



Installation instructions

Akrapovič Exhaust Systems:
Tail Pipes, Slip-On and Evolution
for the
Porsche 911 turbo (type 996T)



Installation instructions

Akrapovič Exhaust Systems:
Tail Pipes, Slip-On and Evolution
for the
Porsche 911 turbo (type 996T)

Congratulations on purchasing an Akrapovič exhaust system. Please read the entire installation manual prior to undertaking any activities related to installation of your new Akrapovič exhaust system. In case you do not fully understand the manual or any of its parts, please contact your authorized dealer!

This product should be installed by someone with sufficient knowledge of exhaust systems and their installation, and appropriate hand or power tools. If you are not qualified for this work, please utilize a certified mechanic for installation. By installing Your Akrapovič exhaust system, you indicate that you have read the installation manual in its entirety and you agree with the terms stated herein.

It is your responsibility to follow all installation instruction guidelines supplied with the Akrapovič exhaust system and undertake all necessary safety precautions. Akrapovič d.d. assumes no responsibility for damages occurring from misuse, abuse, improper installation, improper operation, lack of responsible care, or all previously stated reasons resulting from incompatibility with other manufacturer's products and/or systems.

IMPORTANT INFORMATION

Exclusion of Certain Liability

1. The manufacturer, importer or dealer shall not be liable for any incidental damage including personal injury or any other damages caused by improper installation or operation of the Akrapovič exhaust system. When installing the Akrapovič exhaust system be careful that the exhaust system does not touch other parts sensitive to high temperature.
2. Akrapovič makes no representation or warranties with regard to damage caused by the improper installation, use and maintenance of the Akrapovič exhaust system. The warranty is limited to defects recognized by our technical department and due to normal use, and excludes items subject to normal wear (gaskets and damping wool). The guarantee is void in case of accident, modification, improper or competition use.
3. Do not attempt to install the Akrapovič exhaust system on a vehicle model for which it was not made or tested by Akrapovič.
4. When the exhaust system gets very hot during operation, be careful not to burn yourself on the exhaust system or parts which are in direct contact with it, even when the engine is not running. Also protect other people, especially children, from the injuries mentioned above.

1. In some cases Akrapovič exhaust system kits contain chemical products (ceramic anti-seizing grease; bolt sealant). Handle with care, do not inhale or swallow. Avoid excessive contact with skin, eyes or mucous membranes. Keep out of reach of children.
2. Technical specifications of Akrapovič exhaust systems and related products are subject to change without notice.
3. Before removing the original exhaust system from your vehicle, please compare the parts you received with the list of materials provided in the installation manual in order to assure that you have all the parts necessary for the installation of your new Akrapovič exhaust system.
4. Although this manual consists of instructions for installation in written form, as well as photographs and pictures representing individual steps of the installation, please note that the photographs and pictures are symbolic and are intended for representation of general overview only. The photographs and pictures contained herein should serve as a guideline only and actual installation of the exhaust system may not correspond with the photographs and pictures entirely.
5. The process of uninstalling the original exhaust system may vary depending on the existing exhaust system. Please follow the original exhaust system manufacturer's instructions for uninstalling the original exhaust system.

Trademarks

The Akrapovič Exhaust System Technology logo is a registered trademark of Akrapovič d.d.

Akrapovič website

Information about Akrapovič exhaust systems and related products is available on the Akrapovič website at:

<http://www.akrapovic.com/>

Copyright

No part of the Akrapovič exhaust system or its documentation may be reproduced or distributed in any form or by any means without the prior written authorization of the Akrapovič company.

© Akrapovič, d.d. All rights reserved.



Symbols

The following symbols are used throughout these installation instructions:



TOOLS REQUIRED



TIGHTENING TORQUE



INSTALLATION TIP



CAUTION OR WARNING



USE BOLT SEALANT; Apply 3 to 4 small drops of bolt sealant onto the cleaned and degreased threads before tightening the bolts. **WARNING! Avoid contact with skin, eyes and mucous membranes. Do not inhale fumes. Keep out of the reach of children.**



USE ANTI-SEIZE LEAD-FREE COPPER PASTE (black tube); Provides trouble-free and long-lasting protection against seizing, corrosion and rusting of bolts, threaded ends, nuts, joints, etc. Also protects against vibration, wear and impact. **WARNING! Avoid eye contact. Avoid excessive skin contact. Keep out of reach of children.**



USE ANTI-SEIZING GREASE (white tube); Prevents seizing, corrosion and excessive wear between the titanium components of your exhaust system. **WARNING! Avoid eye contact. Avoid excessive skin contact. Keep out of reach of children.**



T-handle 13 mm wrench
T-handle swiveling 13 mm wrench
T-handle 6 mm three hexagon key wrench
Combination 13 mm wrench
Combination 16 mm wrench
Combination 22 mm wrench
Torx 25
Torx 30
CTX E10
CTX E12

 **BEFORE INSTALLING, CHECK THE SCHEMATIC OF THE EXHAUST SYSTEM!**

! IF ANY ITEMS IN THE AKRAPOVIČ EXHAUST SYSTEM PACKAGE ARE MISSING, PLEASE CONTACT YOUR AUTHORIZED DEALER. KEEP THE SCHEMATIC FOR FUTURE REFERENCE.

! THESE INSTALLATION INSTRUCTIONS MUST BE READ CAREFULLY IN ORDER TO ENSURE PROPER INSTALLATION AND OPERATION OF THE AKRAPOVIČ EXHAUST SYSTEM.

! THE EXHAUST SYSTEM CAN BE EXTREMELY HOT. ALLOW THE EXHAUST AND ENGINE TO COOL DOWN BEFORE BEGINNING INSTALLATION.

 **WE ADVISE YOU TO LEAVE INSTALLATION TO A QUALIFIED SERVICEMAN. IMPROPER INSTALLATION MAY RESULT IN A SHORTER LIFETIME OF THE EXHAUST SYSTEM AND/OR DAMAGE TO THE VEHICLE.**

! WHEN INSTALLING AN AFTERMARKET AKRAPOVIČ EVOLUTION EXHAUST SYSTEM, WHICH IS DEVELOPED FOR USE ON CLOSED TRACK, WE RECOMMEND REMAPPING OF THE ECU TO PREVENT POSSIBLE “ENGINE CHECK LIGHT” WARNING SIGNAL.

REMOVAL OF STOCK EXHAUST SYSTEM:

Put the vehicle onto a car lift.

- ! **WARNING:** make sure, that lifting is safely and correctly done or you risk vehicle damage, injury or even death!
- 1. **For Tail Pipes, Slip-On and Evolution:** untighten the marked stock clamps and remove the stock tail pipes from both sides of the vehicle (**Figure 1**).



Figure 1

2. For Slip-On and Evolution: unscrew marked bolts on both sides of the vehicle (Figure 2).



Figure 2

3. **For Slip-On and Evolution:** disconnect the lights connectors and remove the tail lights (**Figure 3**).

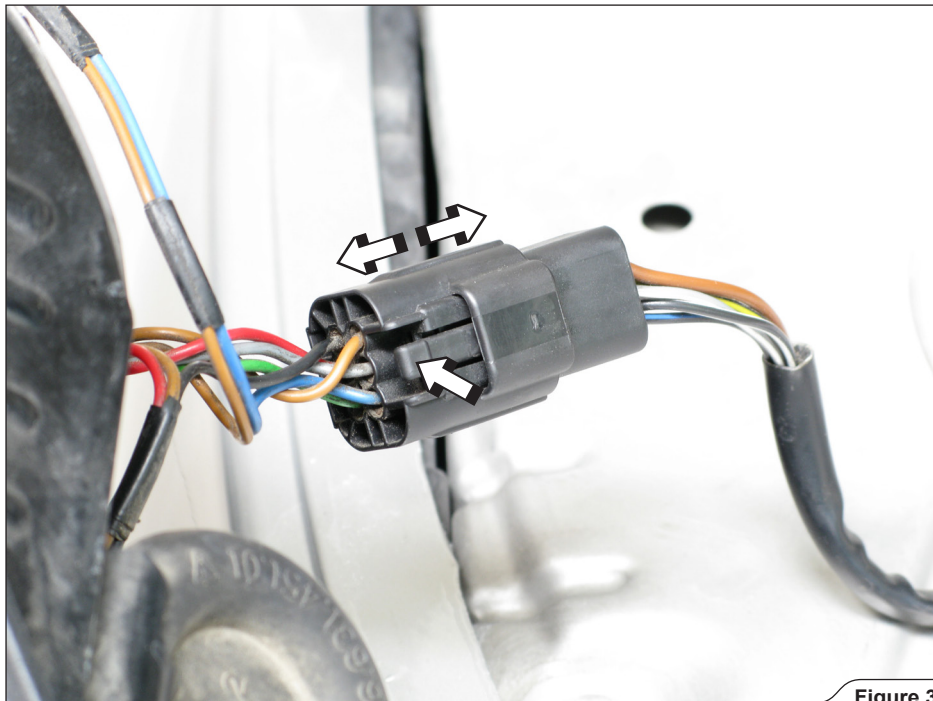

Figure 3

4. For Slip-On and Evolution: unscrew the marked bolts on both sides of the vehicle (Figure 4, 5, 6).



Figure 4



Figure 5



Figure 6

5. **For Slip-On and Evolution:** disconnect the number plate's light and park sensor's connector and remove the rear bumper (**Figure 7**).

! **CAUTION:** be careful not to damage the electrical lead, bumper or any other part of the car during removal!

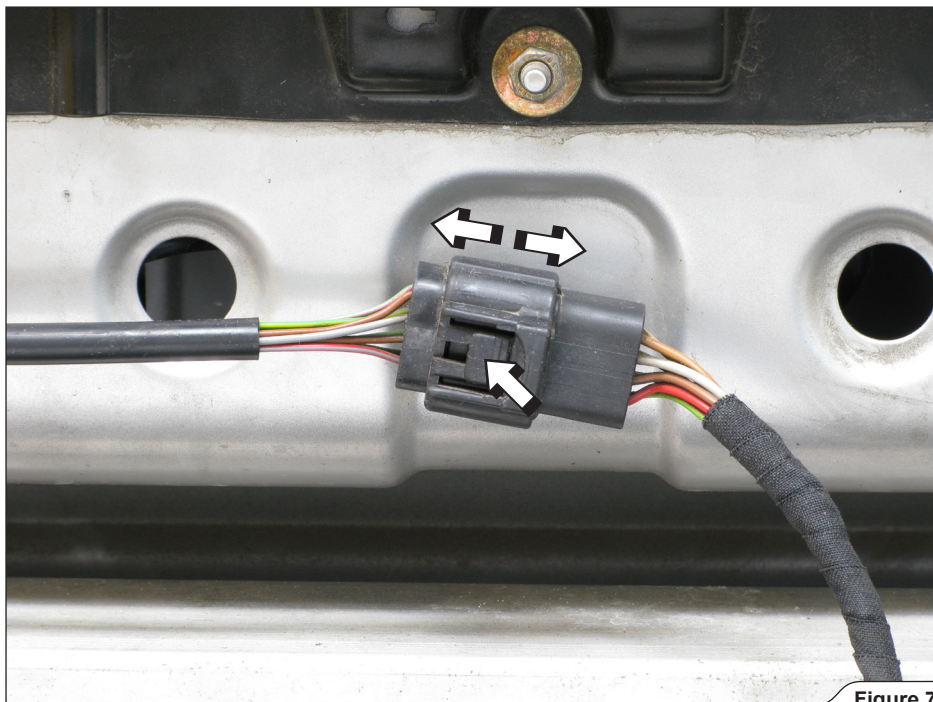

Figure 7

6. **For Slip-On and Evolution:** unscrew the marked bolts on both sides of the vehicle and remove muffler's heat shield (**Figure 8**).



Figure 8

7. **For Slip-On and Evolution:** unscrew the lambda sensors and all nuts of the stock link-pipes on both sides of the vehicle (**Figure 9**).

! **CAUTION:** make sure not to damage the lambda sensors' electrical leads or any other part of the vehicle during this process!

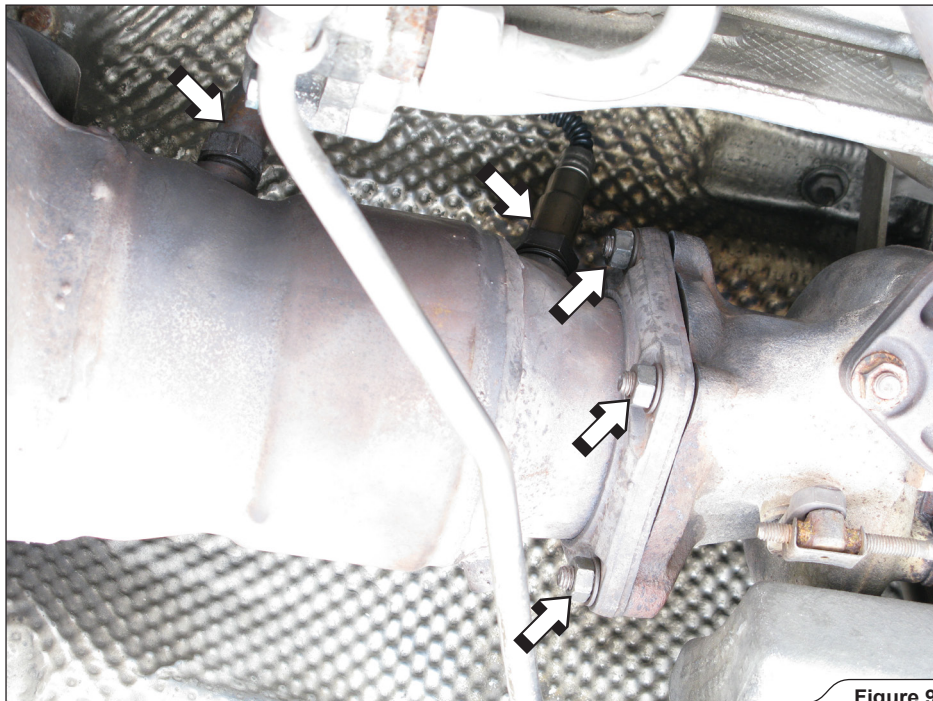

Figure 9

8. **For Slip-On and Evolution:** unscrew the marked muffler clamps and remove the muffler with link-pipes off the vehicle. (Figure 10).

! **CAUTION:** make sure not to damage any part of the vehicle during this process!

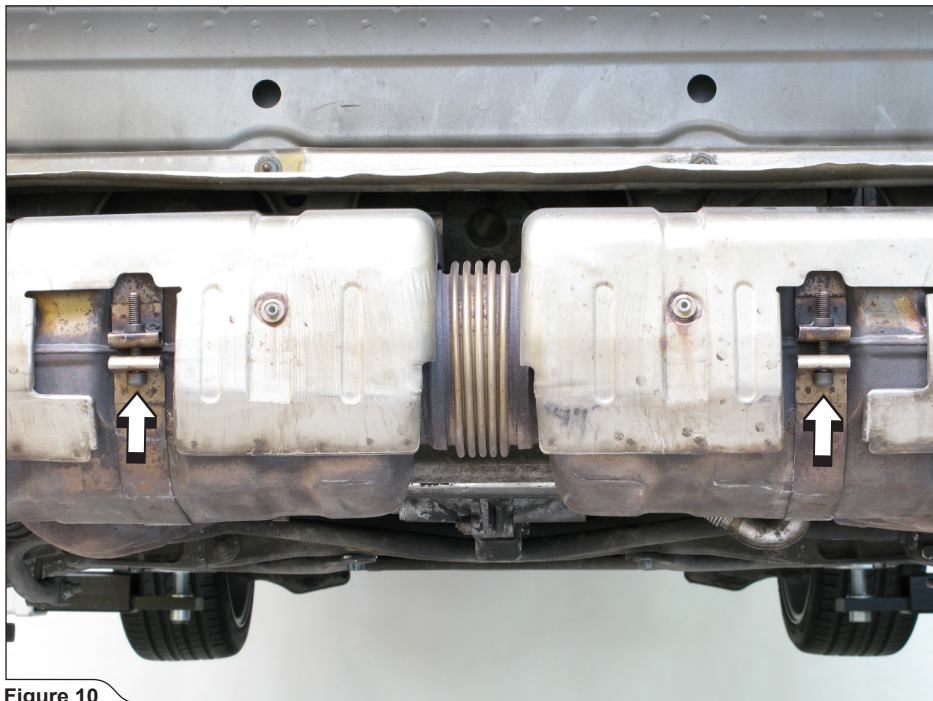

Figure 10

9. **For Evolution:** unscrew marked bolts and nuts of the headers on both sides of the vehicle (**Figure 11**). Remove the headers off the vehicle.

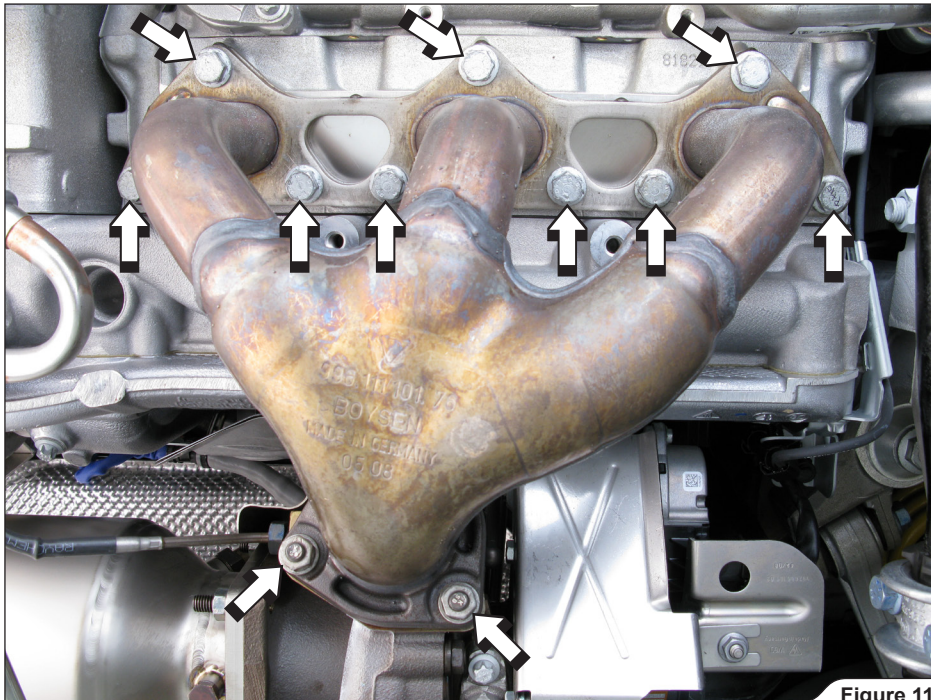

Figure 11

10. **For Evolution:** unscrew the marked double ended stud bolt from the left turbine (**Figure 12**).

! **WARNING:** be careful not to damage the thread or casted casing of the turbine during removal of the double ended stud bolt!

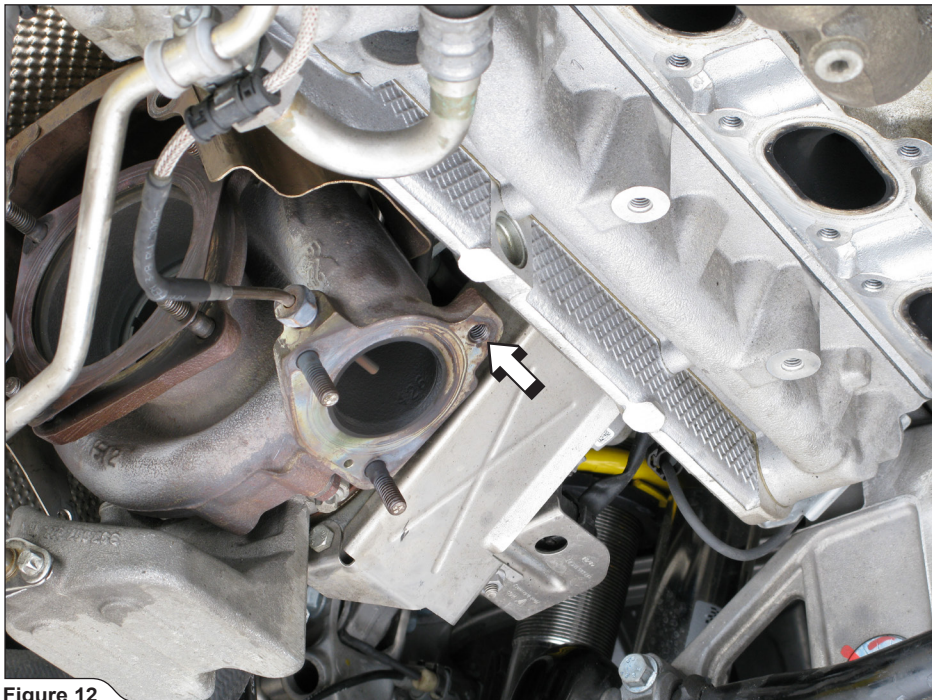

Figure 12

INSTALLATION OF THE AKRAPOVIČ EXHAUST SYSTEMS:

1. **For Evolution:** set the left and right Akrapovič headers with new stock gaskets and hand tighten all bolts and nuts first (**Figure 13, 14**). Tighten bolts and nuts to a specified torque using criss-cross pattern in three steps **on the left side headers only!**

! **WARNING:** use additional Akrapovič titanium bolt on the **LEFT** turbine (**Figure 14**)!

! **CAUTION:** use new exhaust port and header-to-turbine gaskets!

! **WARNING:** use anti-seize copper paste on all bolt and nut threads!

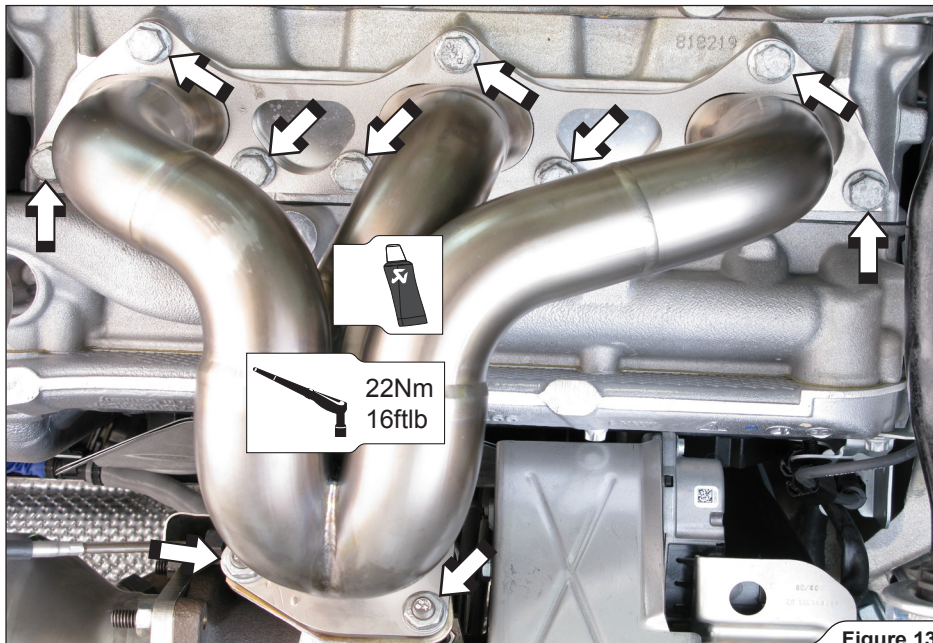

Figure 13

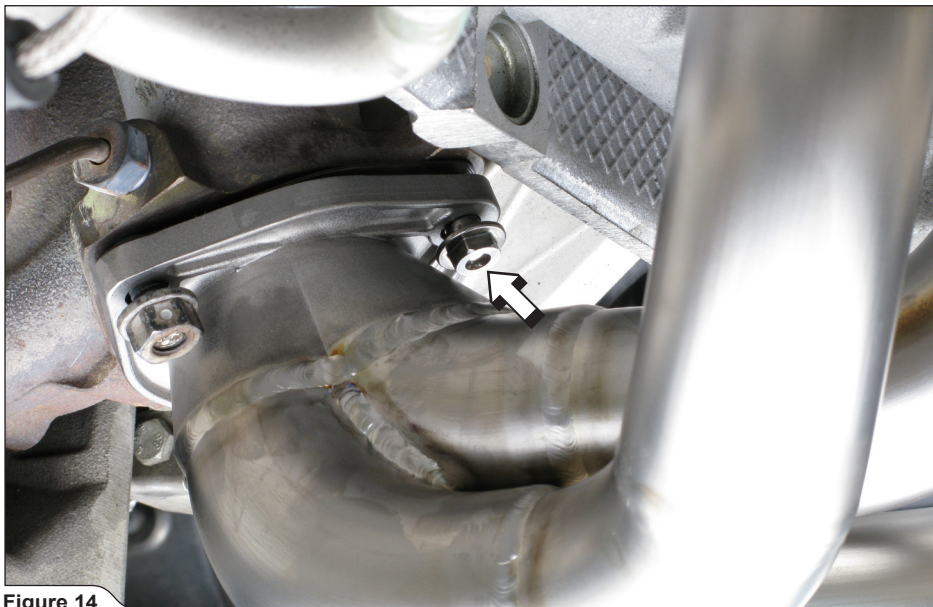

Figure 14

2. **For Slip-On and Evolution:** assemble Akrapovič muffler and link-pipe clamps onto the muffler on both sides as shown; hand tighten the bolts. Insert the link pipe into the muffler (**Figure 15**). Repeat the process on both sides the muffler.

! **WARNING:** use anti-seize copper paste on all clamp bolt threads!

↗ **INSTALLATION TIP:** coat the interior of muffler's inlet bushes with ceramic grease.

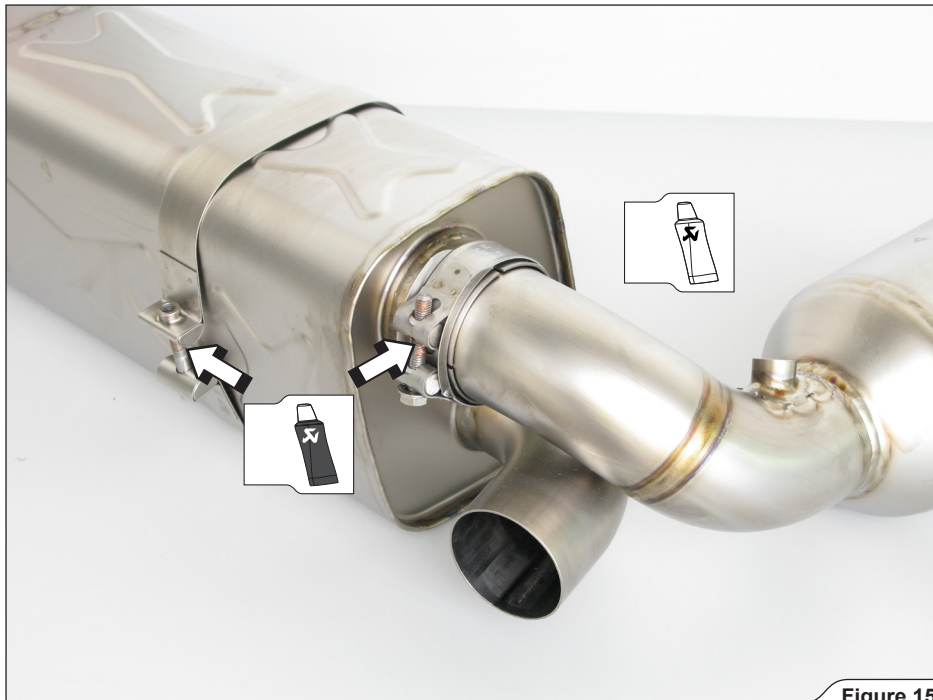

Figure 15

3. **For Slip-On and Evolution:** hang and center the muffler onto stock muffler bracket and simultaneously assemble the link pipes onto the turbine flanges (**Figure 16**). Hand tighten the Akrapovič muffler clamps.

! **WARNING:** make sure that all link pipes are correctly joint with muffler - use rubber mallet, if necessary, to tap the connections into place!

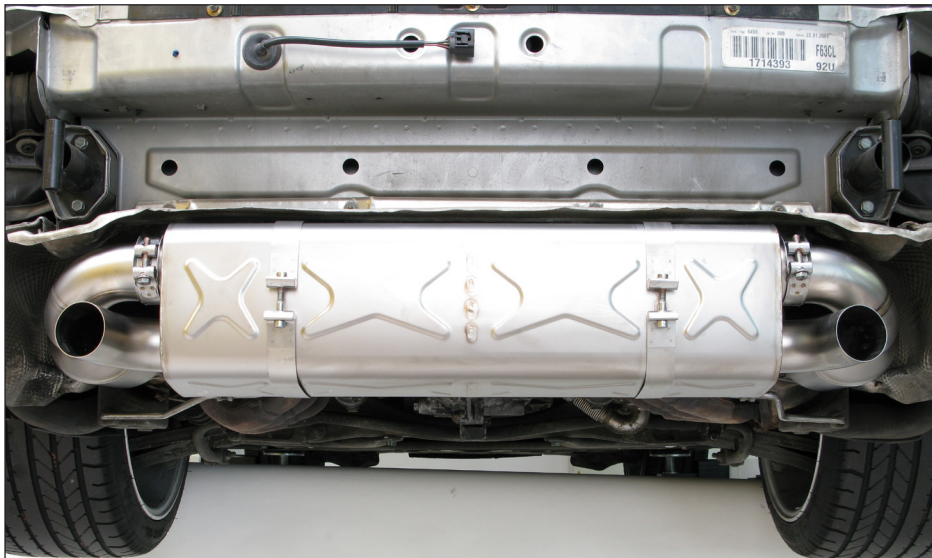

Figure 16

4. **For Slip-On and Evolution:** install and tighten all four lambda sensors on both sides and tighten the link-pipes onto the turbines, using stock nuts and washers (**Figure 17**).

! **WARNING:** use anti-seize copper paste on sensors' threads (only!) and nut threads!

! **CAUTION:** make sure not to damage the sensors' electrical leads during this process!

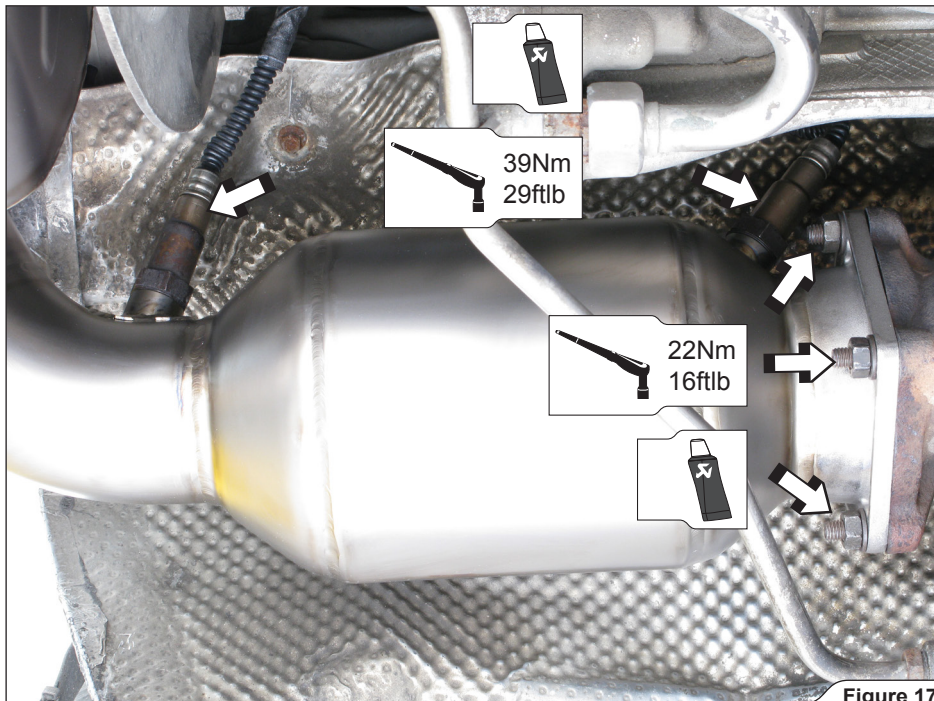

Figure 17

5. **For Slip-On and Evolution:** center and align the muffler in respect to the vehicle chassis (**Figure 23**). Tighten all muffler clamps to a specified torque (**Figure 18**). **Now tighten the right side headers to a specified torque (Figure 13; Page 20)!**

! **WARNING:** use anti-seize copper paste on all bolt threads!

! **WARNING:** make sure that muffler seats correctly on the stock muffler bracket!

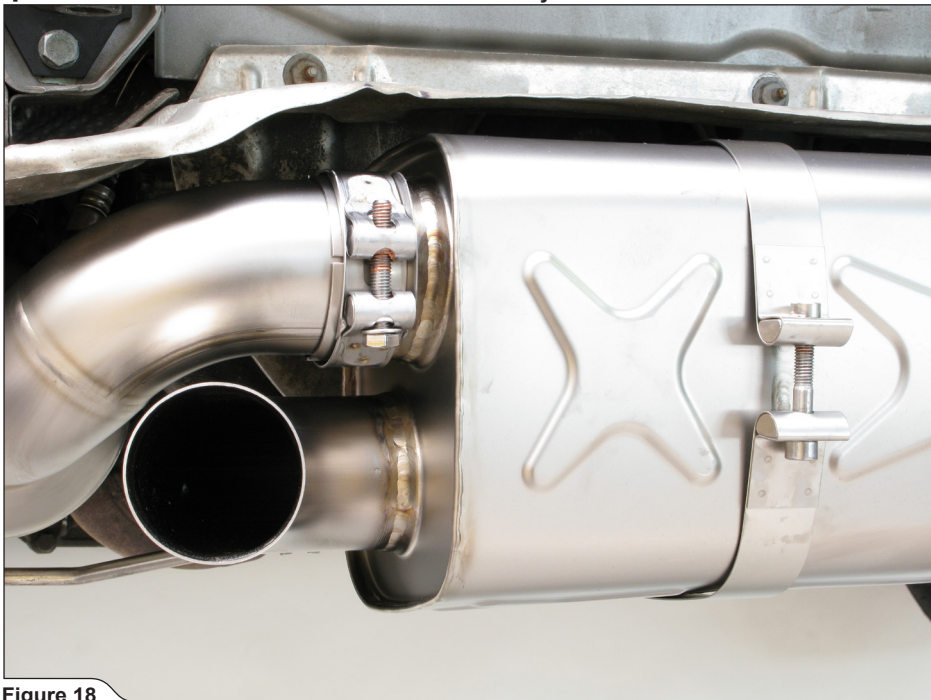

Figure 18

6. **For Tail Pipes, Slip-On and Evolution:** assemble the clamps and spherical rings onto the Tail Pipes as shown (Figure 19).

! **WARNING:** use anti-seize copper paste on clamp bolt threads!



Figure 19

7. **For Tail Pipes only:** slide the reduction rings onto both stock muffler outlets (**Figure 20**).
! **WARNING:** use anti-seize copper paste on the interior of the reduction bushes!

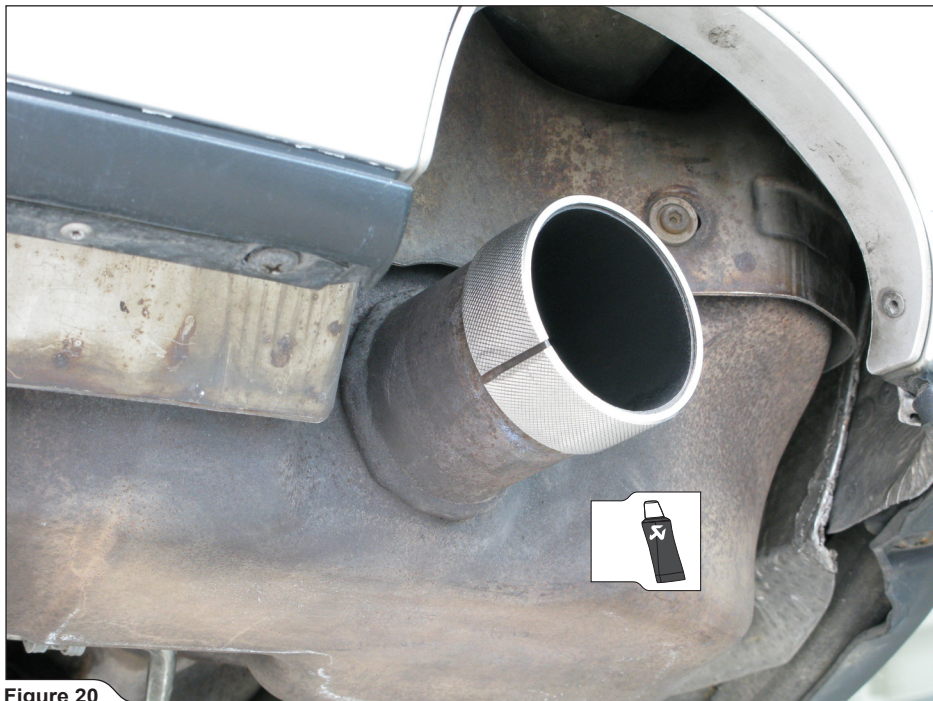

Figure 20

8. **For Tail Pipes, Slip-On and Evolution:** replace the dismantled rear bumper in the reverse order from the order in which it was removed. Check vehicle manufacturer manual for tightening torques. Slide and center the Akrapovič tail-pipes (in respect to rear bumper) onto the muffler's outlet pipes as shown on both sides of the vehicle (**Figure 21**).

✂ **INSTALLATION TIP:** coat the interior of the inlet bushes of the tail pipes with anti-seize copper paste.



Figure 21

9. **For Tail Pipes only:** tighten the Tail Pipe clamps to a specified torque (**Figure 22**).

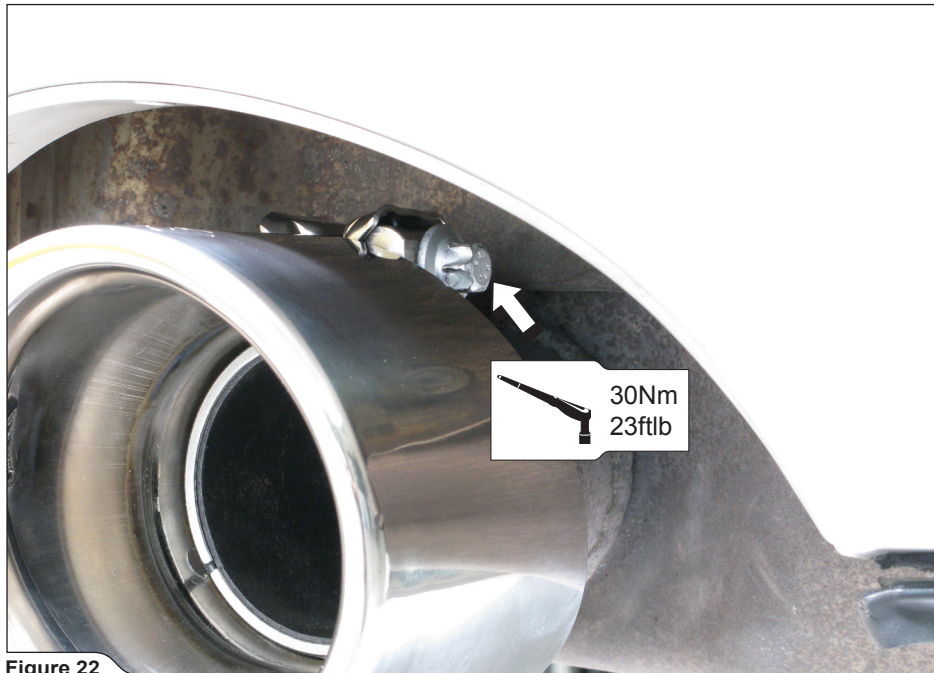

Figure 22

10. **For Slip-On and Evolution:** tighten the Tail Pipe clamps to a specified torque (**Figure 27**).

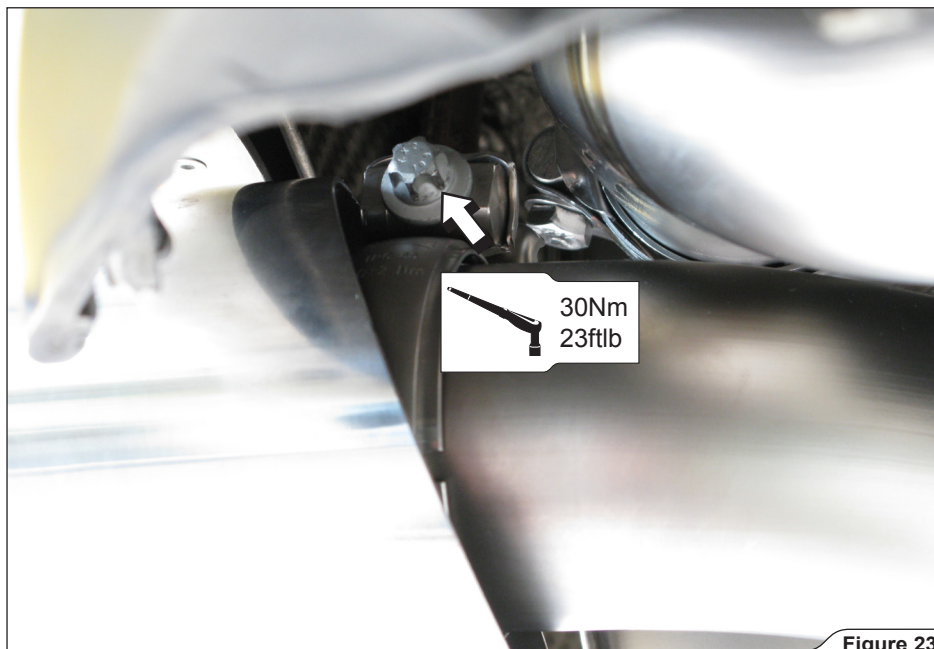

Figure 23

Final installation:

11. Replace all of the dismantled stock parts in the reverse order from the order in which they were removed.
- ! **WARNING: check vehicle manufacturer manual for tightening torques (for dismantled stock parts)!**
 - ! **WARNING: make sure all the nuts and bolts are sufficiently tightened. In case the exhaust system touches the cowling or other parts, repeat the adjustment of the exhaust system or contact your authorized dealer.**

MAINTENANCE OF THE AKRAPOVIČ EXHAUST SYSTEM

1. Clean the titanium exhaust components with a multi-purpose spray lubricant (WD-40 or equivalent), carbon fiber exhaust components with soft and dry cloth and stainless steel components with soft cloth sprayed with contact cleaner, then wipe with soft and dry cloth. A change in the color of the exhaust system is normal due to high temperatures.
 2. Periodically make sure all the bolts and springs are sufficiently tight.
- ! **WARNING: clean all exhaust components before the first start of the engine or the stains will burn onto the surfaces!**
 - ! **IT IS NORMAL IF WHITE SMOKE COMES OUT OF THE MUFFLER ON FIRST OPERATION.**
 - ! **DO NOT STAND BEHIND THE MUFFLER ON FIRST OPERATION.**
 - ! **DO NOT USE AUTOMOTIVE WHEEL CLEANERS OR ANY CLEANING PRODUCTS WHICH CONTAIN ACIDIC ADDITIVES TO CLEAN AKRAPOVIČ EXHAUST SYSTEMS.**

PORSCHE 996T/Titanium exhaust system "SLIP ON" 2001

Product code:

S-PO996TH (catalysts 400 cpsl)

S-PO996T (catalysts 100 cpsl)

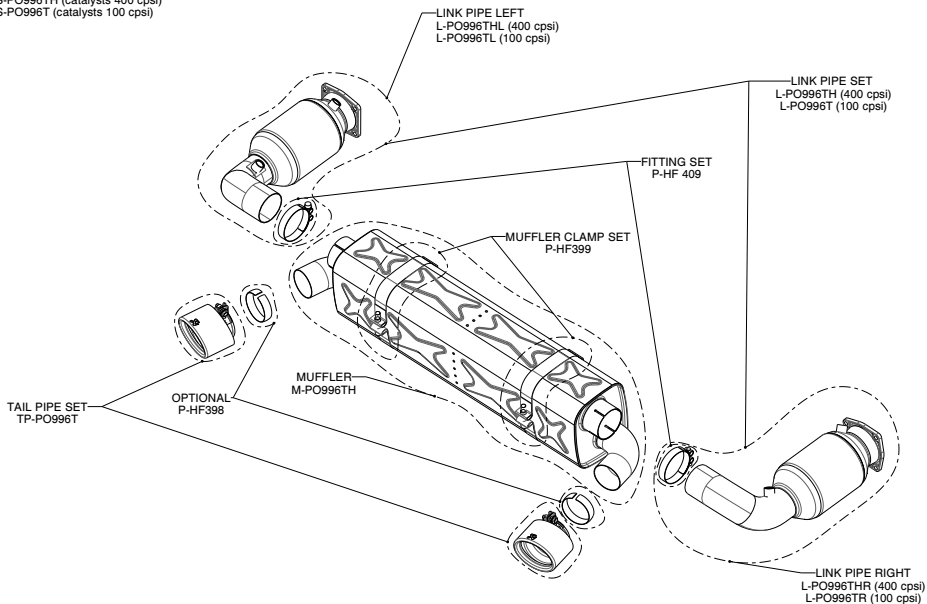

PORSCHE 996T/Titanium exhaust system "EVOLUTION" 2001

Product code:

S-PO996TE (catalysts 400 cpsl)

S-PO996TER (catalysts 100 cpsl)

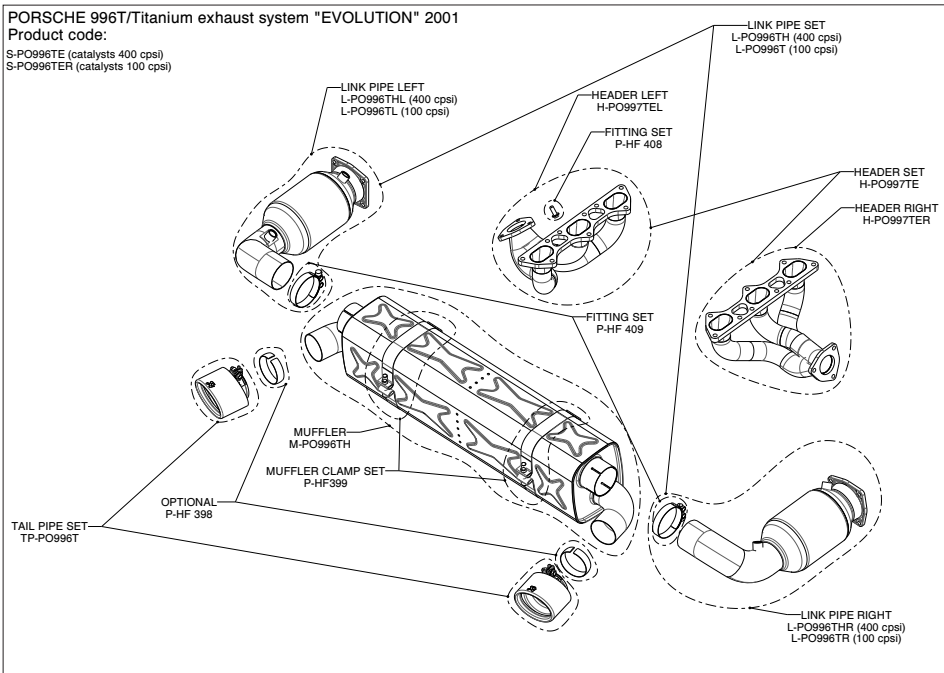

www.akrapovic.com



502415