



Installation instructions

Akrapovič Exhaust Systems:
Evolution
for the
BMW M3 (type E90, E92, E93)



Installation instructions

Akrapovič Exhaust Systems:
Evolution
for the
BMW M3 (type E90, E92, E93)

Congratulations on purchasing an Akrapovič exhaust system. Please read these installation instructions carefully. If you have any trouble installing the system, please contact your authorized dealer!

IMPORTANT INFORMATION

Exclusion of Certain Liability

1. The manufacturer, importer or dealer shall not be liable for any incidental damage including personal injury or any other damages caused by improper installation or operation of the Akrapovič exhaust system. When installing the Akrapovič exhaust system be careful that the exhaust system does not touch other parts sensitive to high temperature.
2. Akrapovič makes no representation or warranties with regard to damage caused by the improper installation, use and maintenance of the Akrapovič exhaust system. The warranty is limited to defects recognized by our technical department and due to normal use, and excludes items subject to normal wear (gaskets and damping wool). The guarantee is void in case of accident, modification, improper or competition use.
3. Do not attempt to install the Akrapovič exhaust system on a vehicle model for which it was not made or tested by Akrapovič.
4. When the exhaust system gets very hot during operation, be careful not to burn yourself on the exhaust system or parts which are in direct contact with it, even when the engine is not running. Also protect other people, especially children, from the injuries mentioned above.
5. In some cases Akrapovič exhaust system kits contain chemical products (ceramic anti-seizing grease; bolt sealant). Handle with care, do not inhale or swallow. Avoid excessive contact with skin, eyes or mucous membranes. Keep out of reach of children.
6. Technical specifications of Akrapovič exhaust systems and related products are subject to change without notice.

Trademarks

The Akrapovič Exhaust System Technology logo is a registered trademark of Akrapovič d.d.

Akrapovič website

Information about Akrapovič exhaust systems and related products is available on the Akrapovič website at:

<http://www.akrapovic.com/>

Copyright

No part of the Akrapovič exhaust system or its documentation may be reproduced or distributed in any form or by any means without the prior written authorization of the Akrapovič company.

© Akrapovič, d.d. All rights reserved.

Symbols

The following symbols are used throughout these installation instructions:



TOOLS REQUIRED



TIGHTENING TORQUE



INSTALLATION TIP



CAUTION OR WARNING



USE BOLT SEALANT; Apply 3 to 4 small drops of bolt sealant onto the cleaned and degreased threads before tightening the bolts. **WARNING! Avoid contact with skin, eyes and mucous membranes. Do not inhale fumes. Keep out of the reach of children.**



USE ANTI-SEIZE LEAD-FREE COPPER PASTE (black tube); Provides trouble-free and long-lasting protection against seizing, corrosion and rusting of bolts, threaded ends, nuts, joints, etc. Also protects against vibration, wear and impact. **WARNING! Avoid eye contact. Avoid excessive skin contact. Keep out of reach of children.**



USE ANTI-SEIZING GREASE (white tube); Prevents seizing, corrosion and excessive wear between the titanium components of your exhaust system. **WARNING! Avoid eye contact. Avoid excessive skin contact. Keep out of reach of children.**



T-handle swiveling CTX E12 wrench
T-handle swiveling 13 mm wrench
Combination 13 mm wrench
Combination 22 mm wrench



BEFORE INSTALLING, CHECK THE SCHEMATIC OF THE EXHAUST SYSTEM!



IF ANY ITEMS IN THE AKRAPOVIČ EXHAUST SYSTEM PACKAGE ARE MISSING, PLEASE CONTACT YOUR AUTHORIZED DEALER. KEEP THE SCHEMATIC FOR FUTURE REFERENCE.



THESE INSTALLATION INSTRUCTIONS MUST BE READ CAREFULLY IN ORDER TO ENSURE PROPER INSTALLATION AND OPERATION OF THE AKRAPOVIČ EXHAUST SYSTEM.



THE EXHAUST SYSTEM CAN BE EXTREMELY HOT. ALLOW THE EXHAUST AND ENGINE TO COOL DOWN BEFORE BEGINNING INSTALLATION.



WE ADVISE YOU TO LEAVE INSTALLATION TO A QUALIFIED SERVICEMAN. IMPROPER INSTALLATION MAY RESULT IN A SHORTER LIFETIME OF THE EXHAUST SYSTEM AND/OR DAMAGE TO THE VEHICLE.

REMOVAL OF STOCK EXHAUST SYSTEM:

Put the vehicle onto a car lift.

! **WARNING:** make sure, that car lifting is safely and correctly done or you risk vehicle damage, injury or even death!

1. Unscrew the M8 nuts from stock muffler rubber brackets on both sides of the vehicle (**Figure 1**).

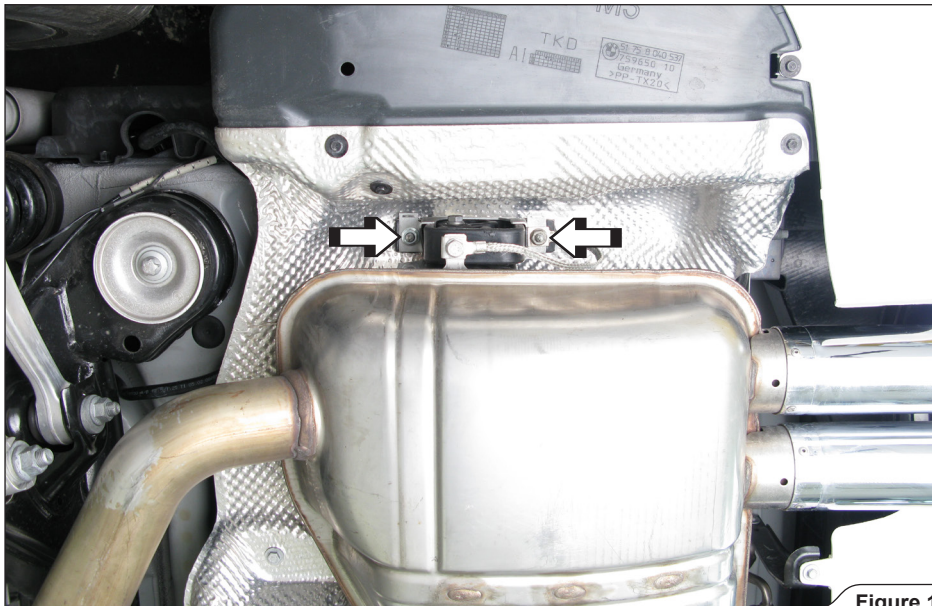

Figure 1

2. Unscrew the marked clamps (**Figure 2**).

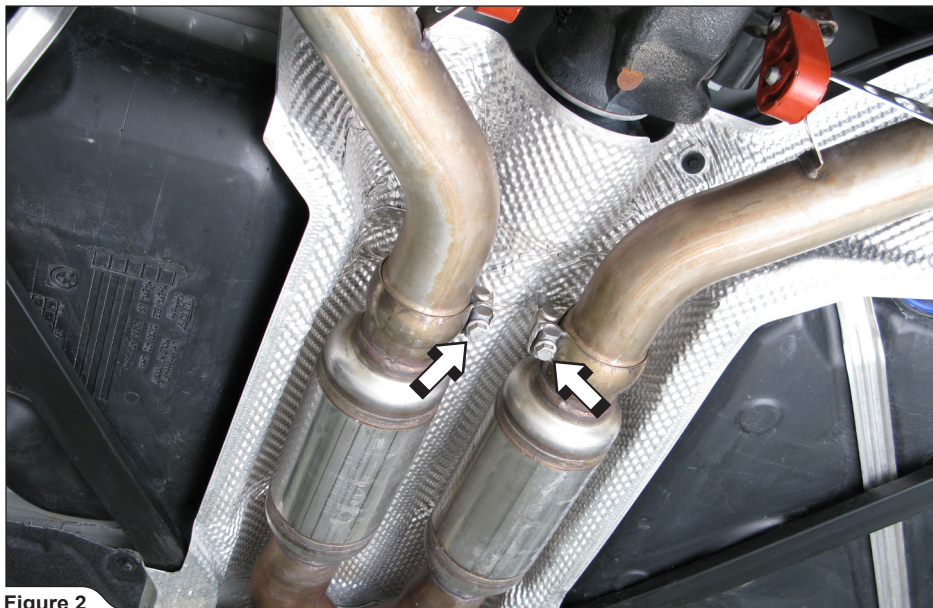

Figure 2

3. Unhook the marked rubber dampers and remove the stock muffler from the vehicle (**Figure 3**).

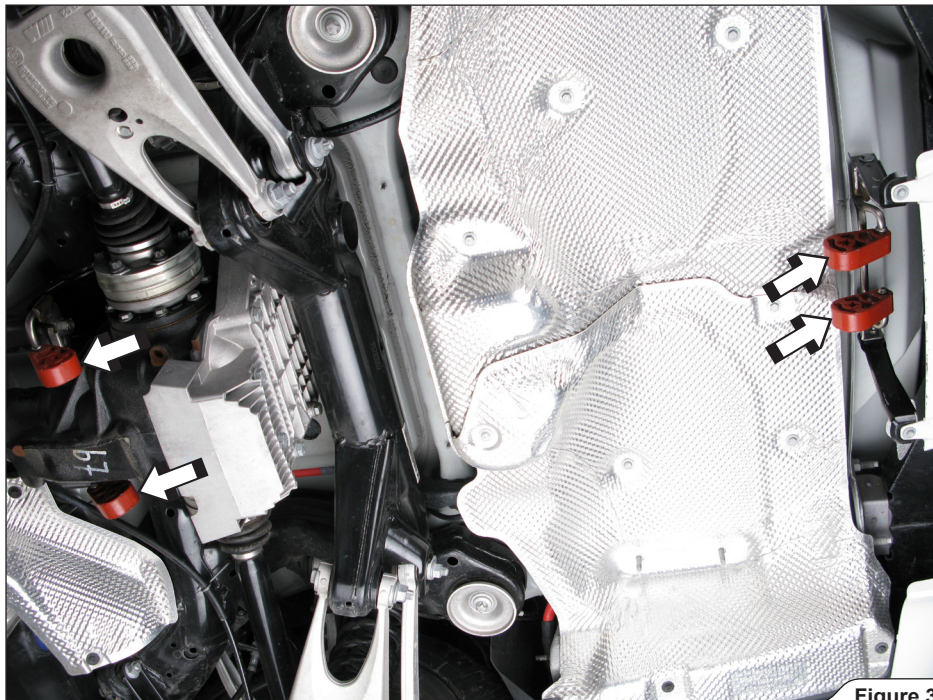

Figure 3

4. Unscrew the marked bolts and nuts on both sides of the vehicle (**Figure 4**).

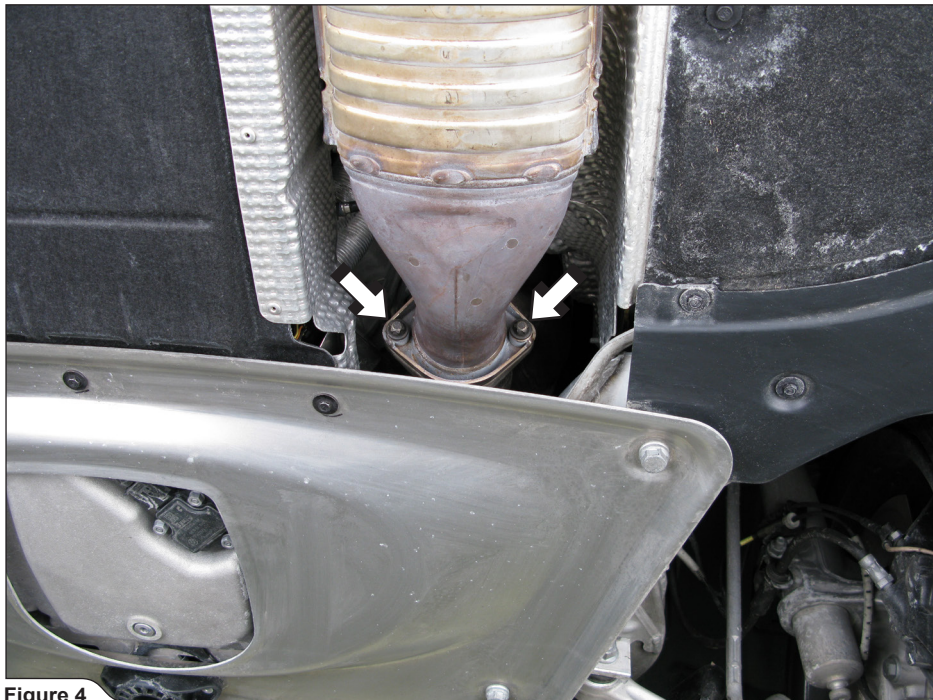

Figure 4

5. Unscrew the marked middle pipes brackets (**Figure 5**).

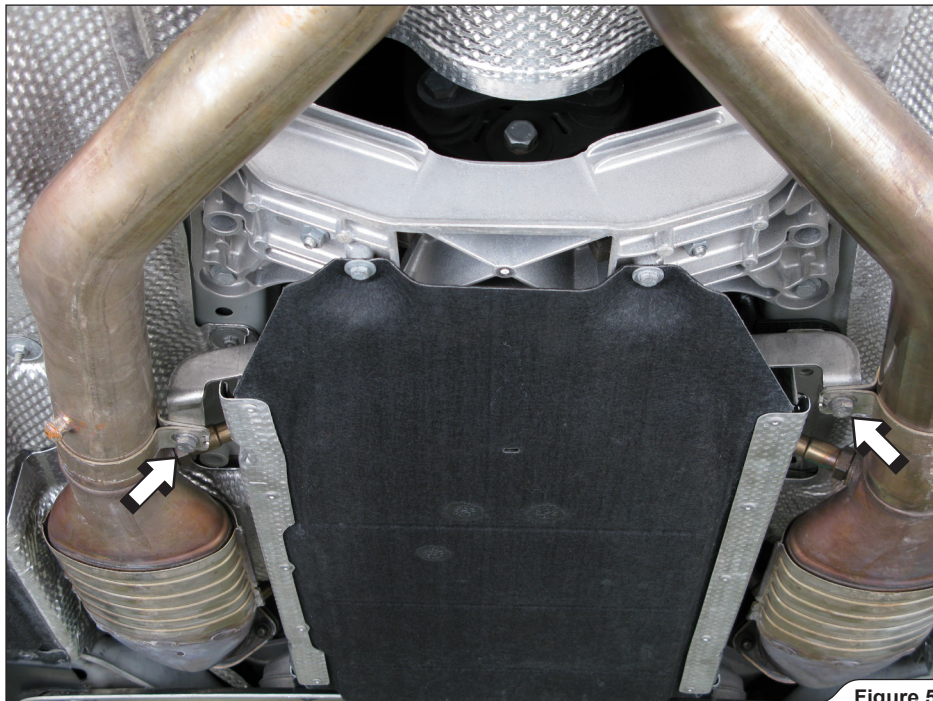

Figure 5

6. Unscrew all four lambda sensors on both sides of the vehicle (**Figure 6**).

! **WARNING:** be careful not to damage the electrical leads of the lambda sensors during this process!

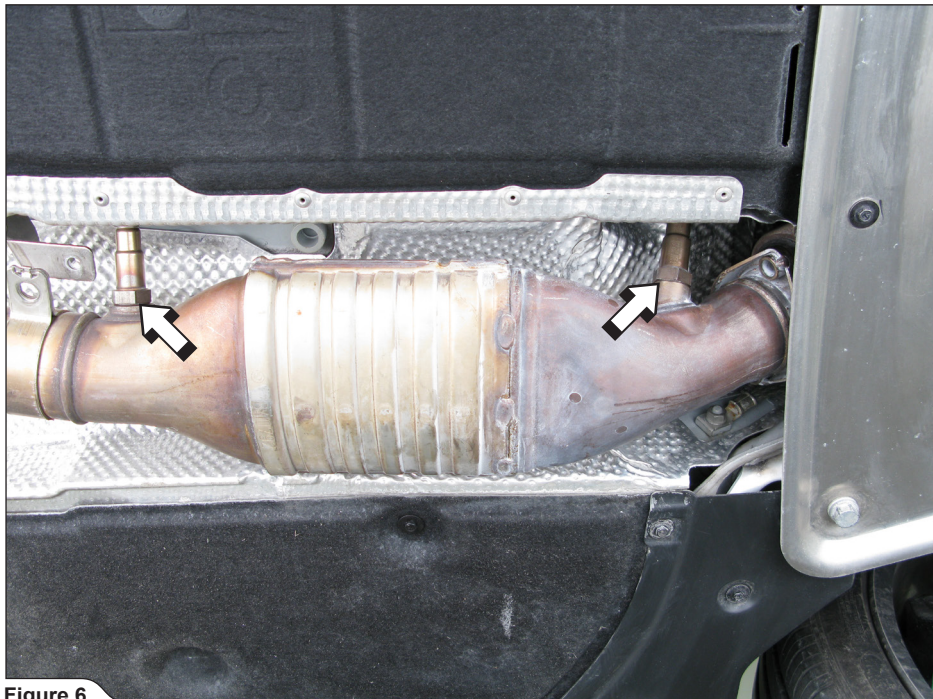

Figure 6

7. Unscrew the marked bolts and remove stock middle pipes together with bracket (**Figure 7**).

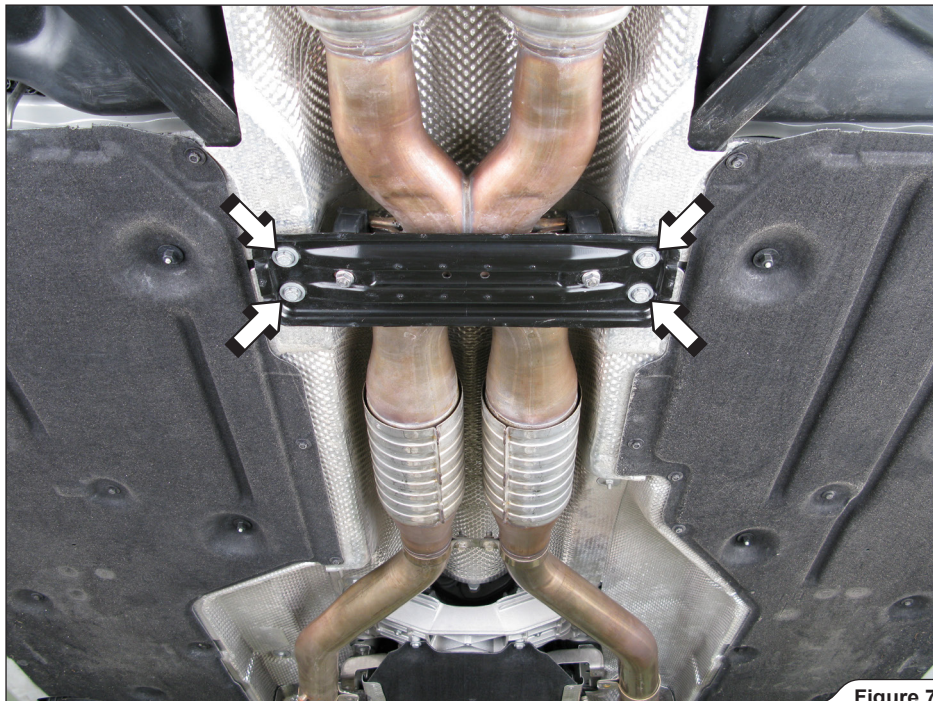

Figure 7

8. Unscrew the marked nuts and remove the bracket from stock middle pipes (**Figure 8**).

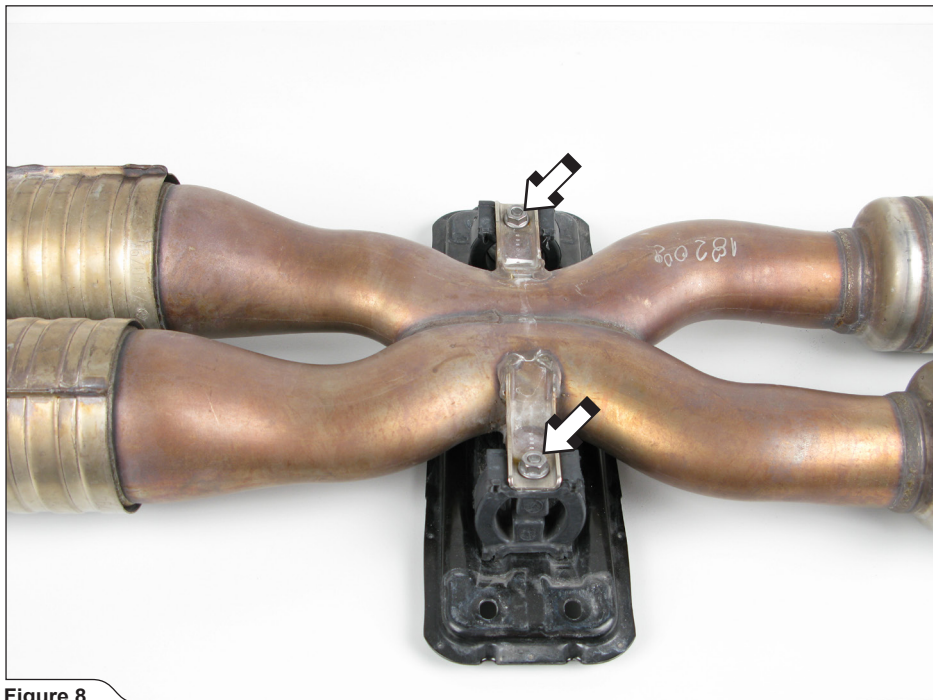

Figure 8

INSTALLATION OF THE AKRAPOVIČ EXHAUST SYSTEMS:

1. Set the Akrapovič headers with additional Akrapovič metal clamps (**Figure 9**).

✂ **INSTALLATION TIP:** coat the interior of the inlet bush of the headers' cross connection with ceramic grease (white tube).



Figure 9

2. Tighten the headers, header's clamps and lambda sensors to a specified torque (**Figure 10**).

! **CAUTION:** use new exhaust gaskets in Akr. headers - stock collectors joints!

! **WARNING:** use anti-seize copper paste on all bolts and nuts threads!

! **WARNING:** use anti-seize copper paste only on sensors' threads!

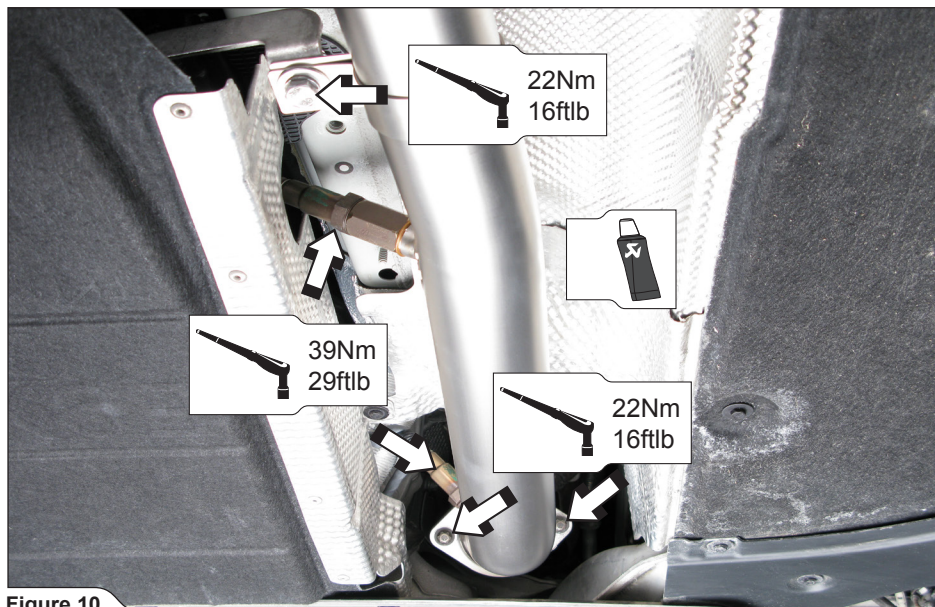

Figure 10

3. Attach the stock bracket and additional metal clamps to Akrapovič middle pipes (**Figure 11**).

! **WARNING:** use anti-seize copper paste on nuts threads (especially on both clamp bolts)!
✂ **INSTALLATION TIP:** coat the interior of the inlet bushes of the middle pipes with ceramic grease (white tube).

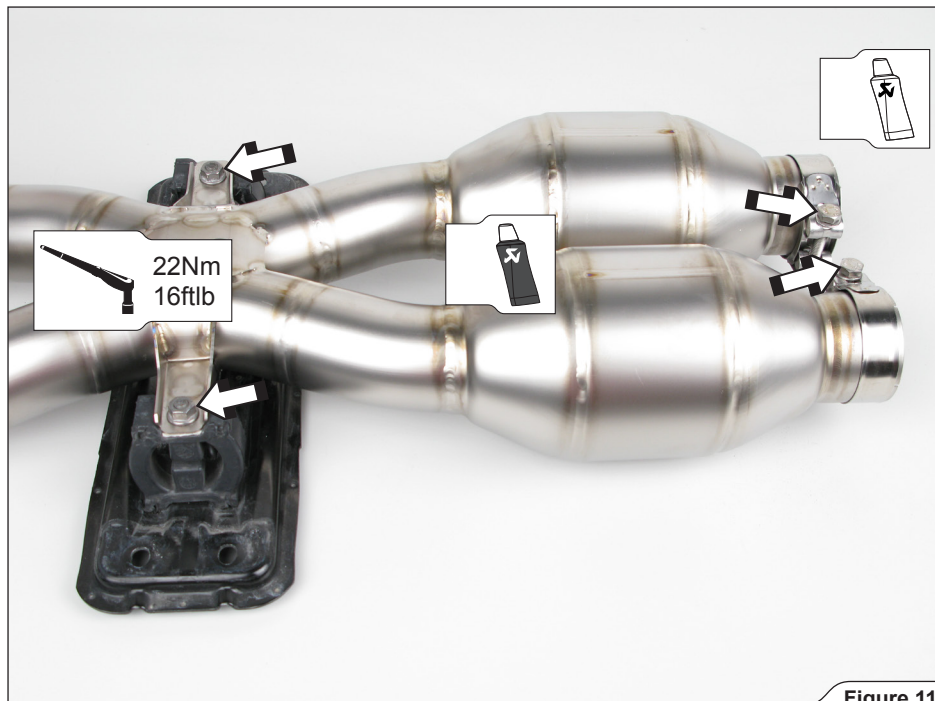

Figure 11

- Slide the middle pipes onto the headers, tighten the stock bracket and clamps to a specified torque (**Figure 12**).

! **WARNING:** use anti-seize copper paste on all bolt threads!

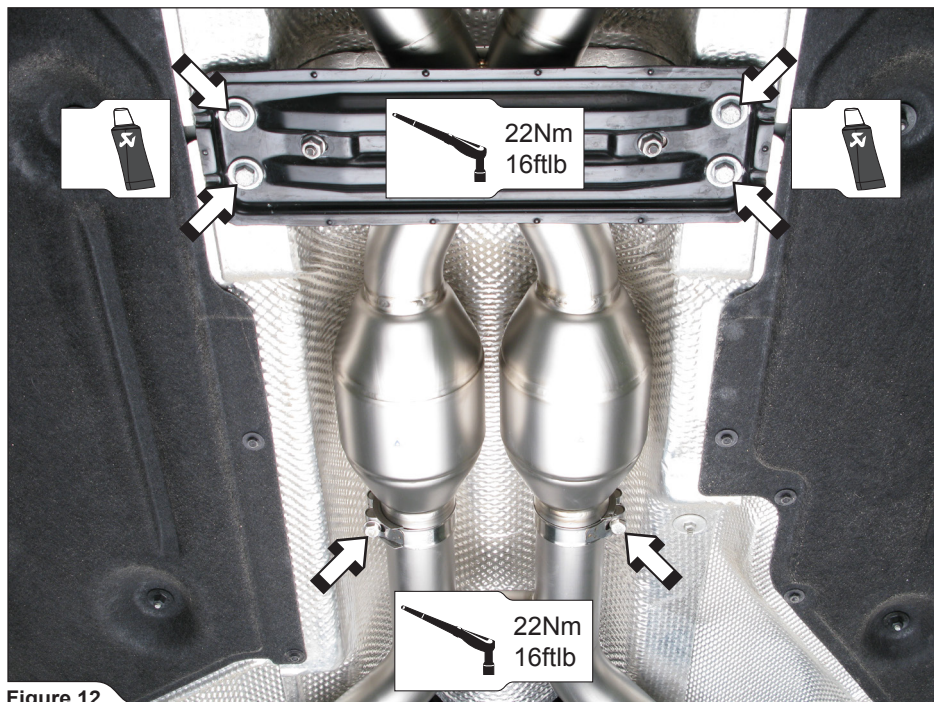

Figure 12

5. Attach the stock muffler brackets (bear in mind, that brackets are not simetrical) and ground wires on both Akrapovič mufflers (**Figure 13**).

! **WARNING:** use anti-seize copper paste on all bolt threads!

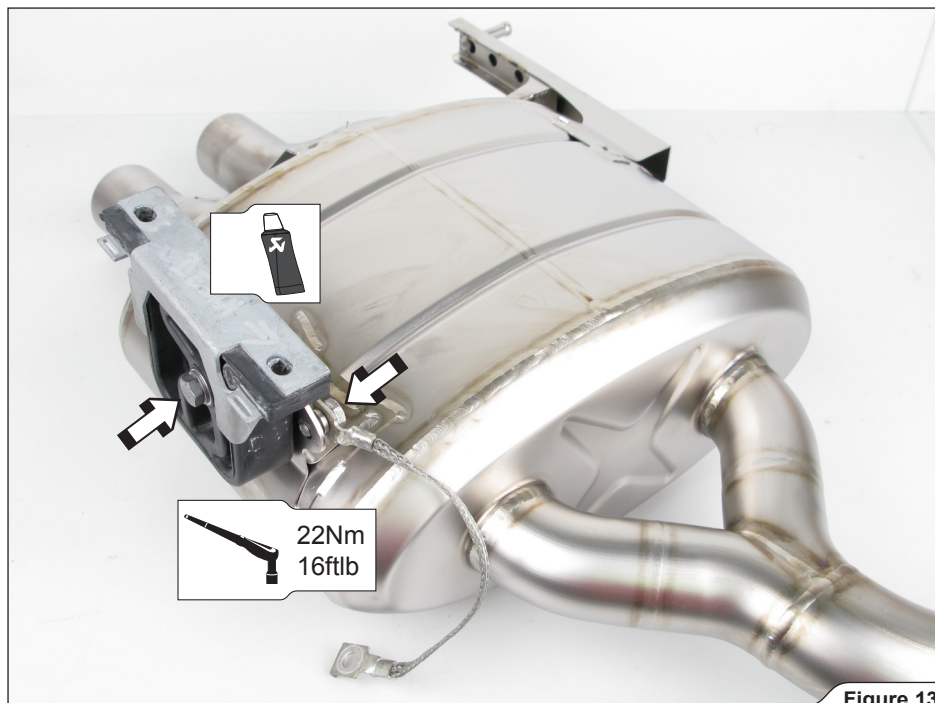

Figure 13

6. Attach additional metal clamps to Akrapovič muffler pipes (**Figure 14**).
! **WARNING:** use anti-seize copper paste on both clamp bolt threads!



Figure 14

7. Apply the ceramic grease to the inlet bushes (Figure 15).

INSTALLATION TIP: coat the interior of the inlet bushes of the muffler pipes with ceramic grease (white tube).

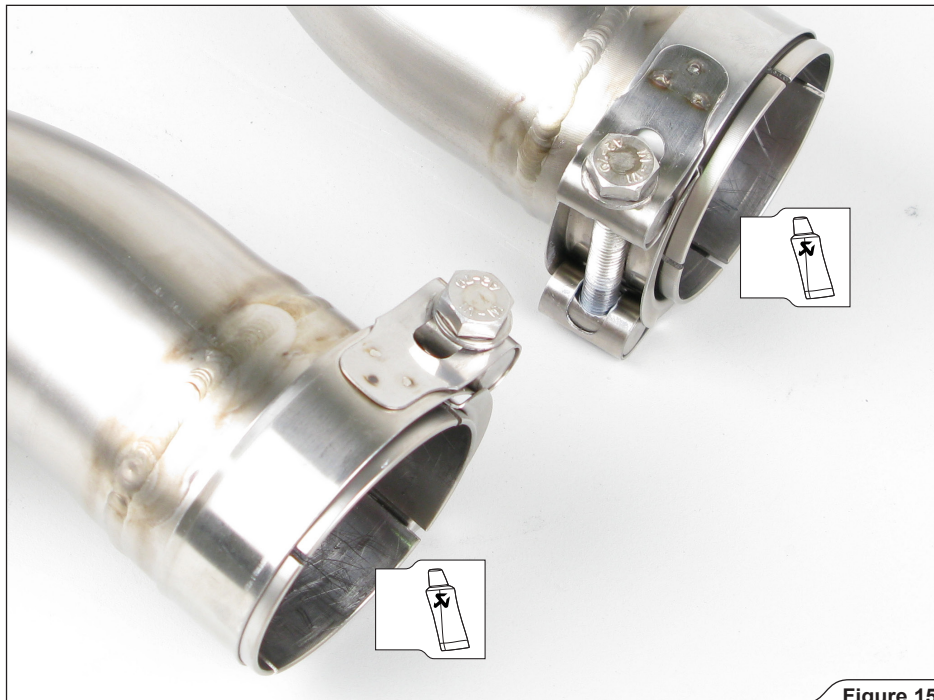

Figure 15

8. Slide both Akrapovič mufflers onto the middle pipes and hang them onto marked stock rubber brackets (**Figure 16**).

! **WARNING:** use anti-seize copper paste on all bolt and nut threads!

✚ **INSTALLATION TIP:** for easier mounting, lubricate the stock rubber brackets.

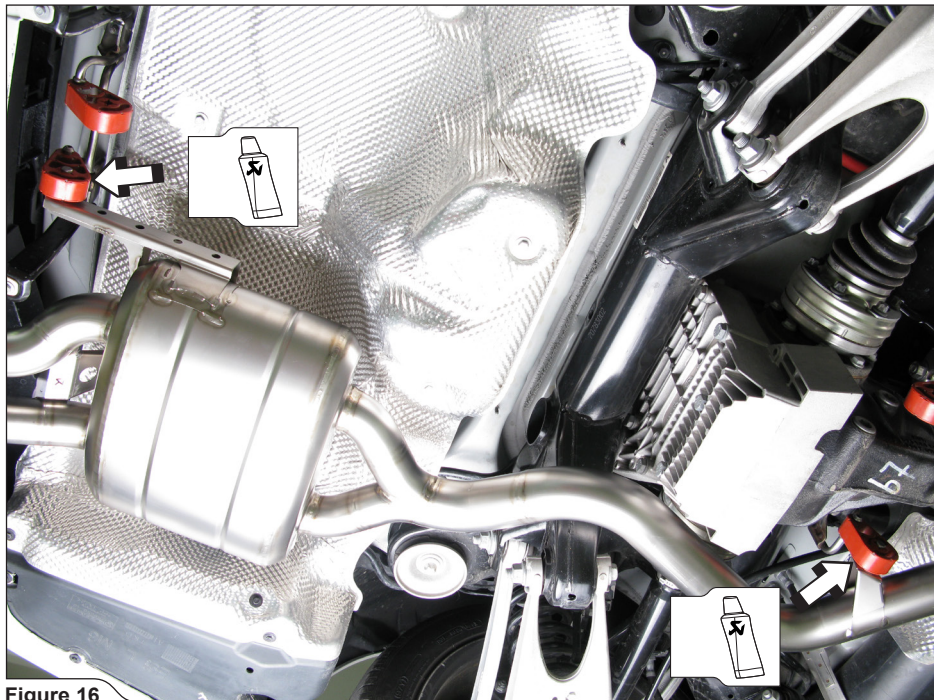

Figure 16

9. Tighten the stock muffler brackets and ground wires to the vehicle chassis (**Figure 19**).

! **WARNING:** use anti-seize copper paste on all nut threads!

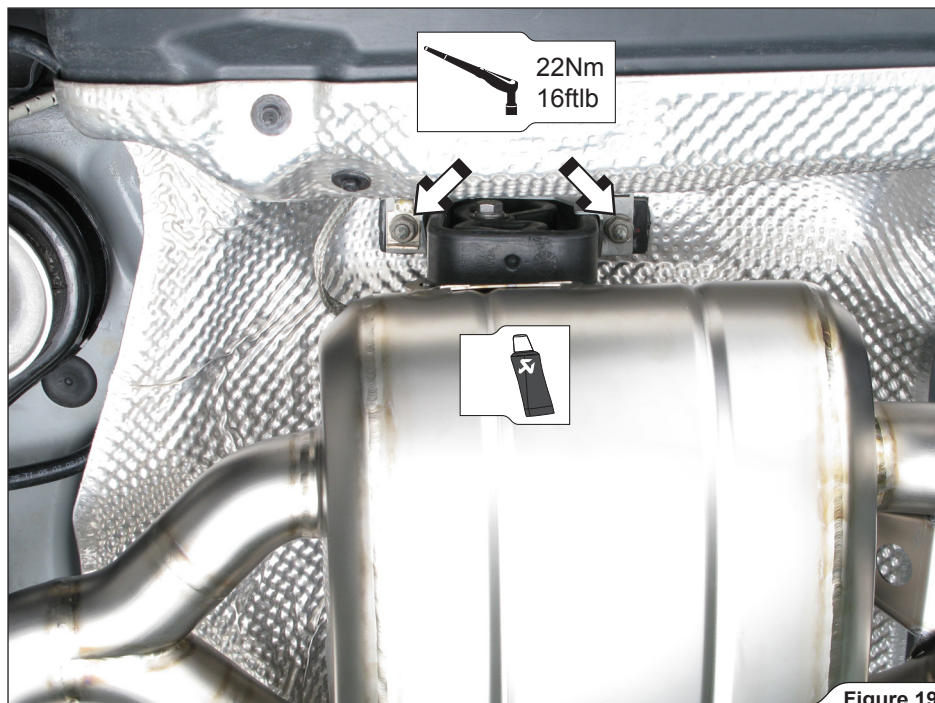

Figure 19

10. Tighten the metal clamps on middle pipes-muffler pipes connections to a specified torque (Figure 20).

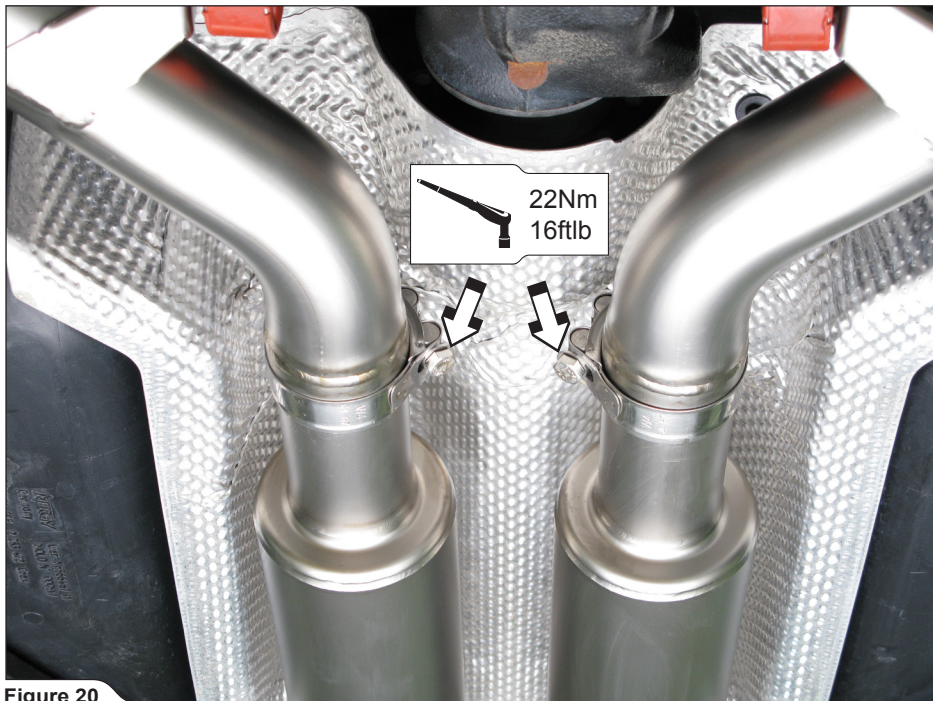

Figure 20

11. Slide and center the Akrapovič tail-pipes (in respect to rear bumper) onto the mufflers' outlet pipes as shown on both sides of the vehicle (**Figure 21**).

✂ **INSTALLATION TIP:** coat the interior of the inlet bushes of the tail pipes with ceramic grease (white tube).

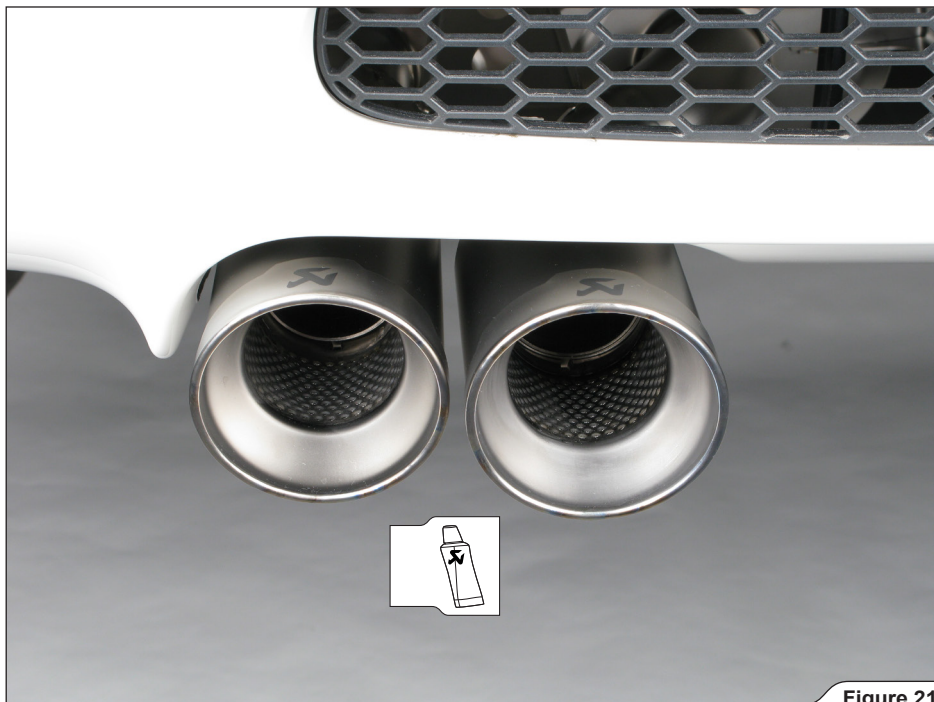

Figure 21

12. Tighten the marked bolts to a specified torque on both sides of the vehicle (**Figure 22**).

! **WARNING:** use anti-seize copper paste on all nut threads!



Figure 22

Final installation:

- ! **WARNING: check vehicle manufacturer manual for tightening torques (for dismantled stock parts)!**
- ! **WARNING: make sure all the nuts and bolts are sufficiently tightened. In case the exhaust system touches the cowling or other parts, repeat the adjustment of the exhaust system or contact your authorized dealer.**

MAINTENANCE OF THE AKRAPOVIČ EXHAUST SYSTEM:

1. Clean the titanium exhaust components with a multi-purpose spray lubricant (WD-40 or equivalent), carbon fiber exhaust components with soft and dry cloth and stainless steel components with soft cloth sprayed with contact cleaner, then wipe with soft and dry cloth. A change in the color of the exhaust system is normal due to high temperatures.
2. Periodically make sure all the bolts and springs are sufficiently tight.

! **WARNING: clean all exhaust components before the first start of the engine or the stains will burn onto the surfaces!**

! **IT IS NORMAL IF WHITE SMOKE COMES OUT OF THE MUFFLER ON FIRST OPERATION.**

! **DO NOT STAND BEHIND THE MUFFLER ON FIRST OPERATION.**

! **DO NOT USE AUTOMOTIVE WHEEL CLEANERS OR ANY CLEANING PRODUCTS WHICH CONTAIN ACIDIC ADDITIVES TO CLEAN AKRAPOVIČ EXHAUST SYSTEMS.**

[EMPTY PAGE]

[EMPTY PAGE]

[EMPTY PAGE]

www.akrapovic.com



502256