



Installation instructions

Akrapovič System:

Evolution and Optional Front Link Pipe Set

for the

Porsche Cayenne Turbo (type 958)

Porsche Cayenne Turbo S (type 958)



Installation instructions

Akrapovič System:

Evolution and **Optional Front Link Pipe Set**

for the

Porsche Cayenne Turbo (type 958)

Porsche Cayenne Turbo S (type 958)

Congratulations on purchasing an Akrapovič exhaust system. Please read the entire installation manual prior to undertaking any activities related to installation of your new Akrapovič exhaust system. In case you do not fully understand the manual or any of its parts, please contact your authorized dealer!

This product should be installed by someone with sufficient knowledge of exhaust systems and their installation, and appropriate hand or power tools. If you are not qualified for this work, please utilize a certified mechanic for installation. By installing Your Akrapovič exhaust system, you indicate that you have read the installation manual in its entirety and you agree with the terms stated herein.

It is your responsibility to follow all installation instruction guidelines supplied with the Akrapovič exhaust system and undertake all necessary safety precautions. Akrapovič d.d. assumes no responsibility for damages occurring from misuse, abuse, improper installation, improper operation, lack of responsible care, or all previously stated reasons resulting from incompatibility with other manufacturer's products and/or systems.

IMPORTANT INFORMATION

Exclusion of Certain Liability

1. The manufacturer, importer or dealer shall not be liable for any incidental damage including personal injury or any other damages caused by improper installation or operation of the Akrapovič exhaust system. When installing the Akrapovič exhaust system be careful that the exhaust system does not touch other parts sensitive to high temperature.
2. Akrapovič makes no representation or warranties with regard to damage caused by the improper installation, use and maintenance of the Akrapovič exhaust system. The warranty is limited to defects recognized by our technical department and due to normal use, and excludes items subject to normal wear (gaskets and damping wool). The guarantee is void in case of accident, modification, improper or competition use.
3. Do not attempt to install the Akrapovič exhaust system on a vehicle model for which it was not made or tested by Akrapovič.
4. When the exhaust system gets very hot during operation, be careful not to burn yourself on the exhaust system or parts which are in direct contact with it, even when the engine is not running. Also protect other people, especially children, from the injuries mentioned above.

1. In some cases Akrapovič exhaust system kits contain chemical products (ceramic anti-seizing grease; bolt sealant). Handle with care, do not inhale or swallow. Avoid excessive contact with skin, eyes or mucous membranes. Keep out of reach of children.
2. Technical specifications of Akrapovič exhaust systems and related products are subject to change without notice.
3. Before removing the original exhaust system from your vehicle, please compare the parts you received with the list of materials provided in the installation manual in order to assure that you have all the parts necessary for the installation of your new Akrapovič exhaust system.
4. Although this manual consists of instructions for installation in written form, as well as photographs and pictures representing individual steps of the installation, please note that the photographs and pictures are symbolic and are intended for representation of general overview only. The photographs and pictures contained herein should serve as a guideline only and actual installation of the exhaust system may not correspond with the photographs and pictures entirely.
5. The process of uninstalling the original exhaust system may vary depending on the existing exhaust system. Please follow the original exhaust system manufacturer's instructions for uninstalling the original exhaust system.

Trademarks

The Akrapovič Exhaust System Technology logo is a registered trademark of Akrapovič d.d.

Akrapovič website

Information about Akrapovič exhaust systems and related products is available on the Akrapovič website at:

<http://www.akrapovic.com/>

Copyright

No part of the Akrapovič exhaust system or its documentation may be reproduced or distributed in any form or by any means without the prior written authorization of the Akrapovič company.

© Akrapovič, d.d. All rights reserved.

Symbols

The following symbols are used throughout these installation instructions:



TOOLS REQUIRED



TIGHTENING TORQUE



INSTALLATION TIP



CAUTION OR WARNING



USE BOLT SEALANT; Apply 3 to 4 small drops of bolt sealant onto the cleaned and degreased threads before tightening the bolts. **WARNING! Avoid contact with skin, eyes and mucous membranes. Do not inhale fumes. Keep out of the reach of children.**



USE ANTI-SEIZE LEAD-FREE COPPER PASTE (black tube); Provides trouble-free and long-lasting protection against seizing, corrosion and rusting of bolts, threaded ends, nuts, joints, etc. Also protects against vibration, wear and impact. **WARNING! Avoid eye contact. Avoid excessive skin contact. Keep out of reach of children.**



USE ANTI-SEIZING GREASE (white tube); Prevents seizing, corrosion and excessive wear between the titanium components of your exhaust system. **WARNING! Avoid eye contact. Avoid excessive skin contact. Keep out of reach of children.**



T-handle swivelling 12 mm wrench
T-handle swivelling 13 mm wrench
Combination 12mm wrench
Combination 13mm wrench
Bi-hex 15 mm socket
Pry bar



BEFORE INSTALLING, CHECK SCHEMATIC OF THE EXHAUST SYSTEM! THE LATEST VERSION OF THE PARTS LIST AND SCHEMATIC DRAWINGS OF THE PRODUCTS ARE AVAILABLE ON OUR WEB PAGE.



IF ANY ITEMS IN THE AKRAPOVIČ EXHAUST SYSTEM PACKAGE ARE MISSING, PLEASE CONTACT YOUR AUTHORIZED DEALER. KEEP THE SCHEMATIC FOR FUTURE REFERENCE.



THESE INSTALLATION INSTRUCTIONS MUST BE READ CAREFULLY IN ORDER TO ENSURE PROPER INSTALLATION AND OPERATION OF THE AKRAPOVIČ EXHAUST SYSTEM.



THE EXHAUST SYSTEM CAN BE EXTREMELY HOT. ALLOW THE EXHAUST AND ENGINE TO COOL DOWN BEFORE BEGINNING INSTALLATION.



WE ADVISE YOU TO LEAVE INSTALLATION TO A QUALIFIED SERVICEMAN. IMPROPER INSTALLATION MAY RESULT IN A SHORTER LIFETIME OF THE EXHAUST SYSTEM AND/OR DAMAGE TO THE VEHICLE.



THIS MANUAL IS SPECIFIC TO THE PORSCHE CAYENNE TURBO. THERE MAY BE SOME DIFFERENCES IN INSTALLATION PROCEDURES FOR OTHER MODELS.

INSTALLATION OF THE AKRAPOVIČ EXHAUST SYSTEM:

1. Put the vehicle onto a car lift.

! **WARNING: ensure that the car is lifted safely and properly in order to avoid the risk of vehicle damage, injury, or even death!**

2. Remove the stock muffler off the vehicle.

↗ **INSTALLATION TIP: check the Akrapovič Slip-On installation instructions for correct muffler disassembly procedure.**

! **WARNING: make sure, not to injure yourself or damage any part of the vehicle during this procedure!**

3. **For both systems:** loosen the marked double clamps' nuts, unscrew the rubber bracket and carefully remove the stock middle link pipes off the vehicle (**Figure 1, 2**).
- !** **WARNING:** make sure not to injure yourself, or damage any part of the vehicle during this procedure!

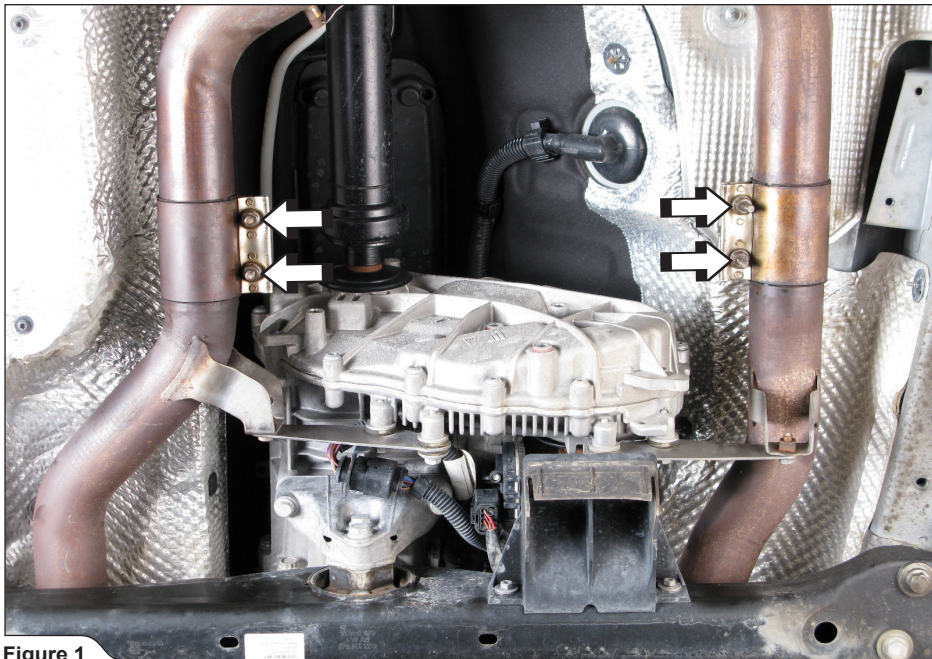

Figure 1

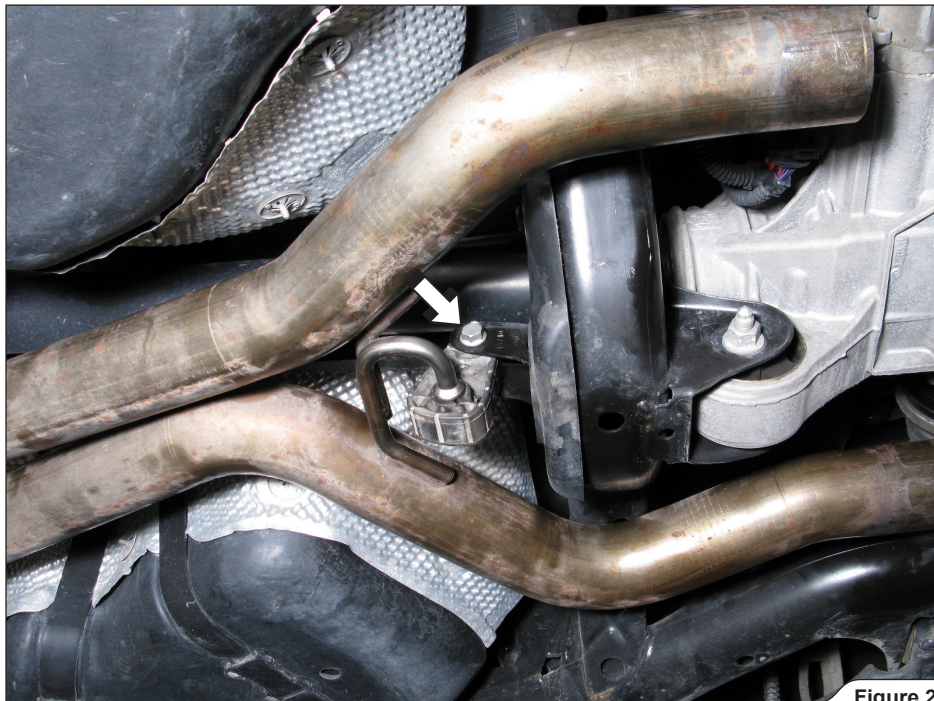

Figure 2

4. For Optional Front Link Pipe Set only: unscrew the marked flange nuts on both sides (Figure 3).

! **WARNING:** make sure not to injure yourself, or damage any part of the vehicle during this procedure!

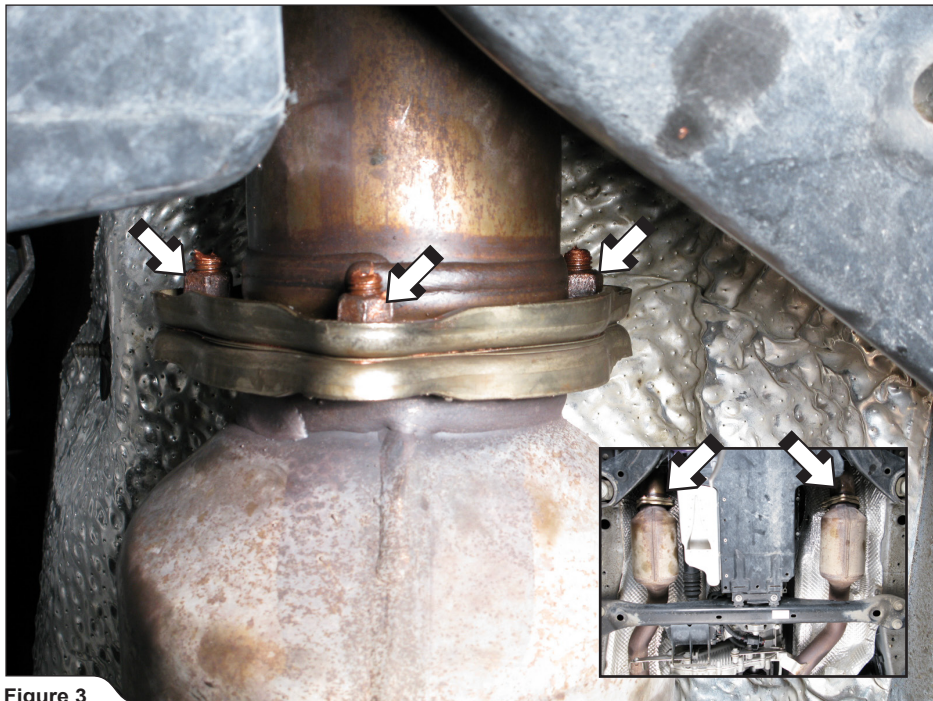

Figure 3

5. **For Optional Front Link Pipe Set only:** unscrew the marked bolts and carefully remove the stock front link pipes off the vehicle (**Figure 4**).

! **WARNING:** make sure, that you support the stock front link pipes during this procedure or you could injure yourself or damage the vehicle!

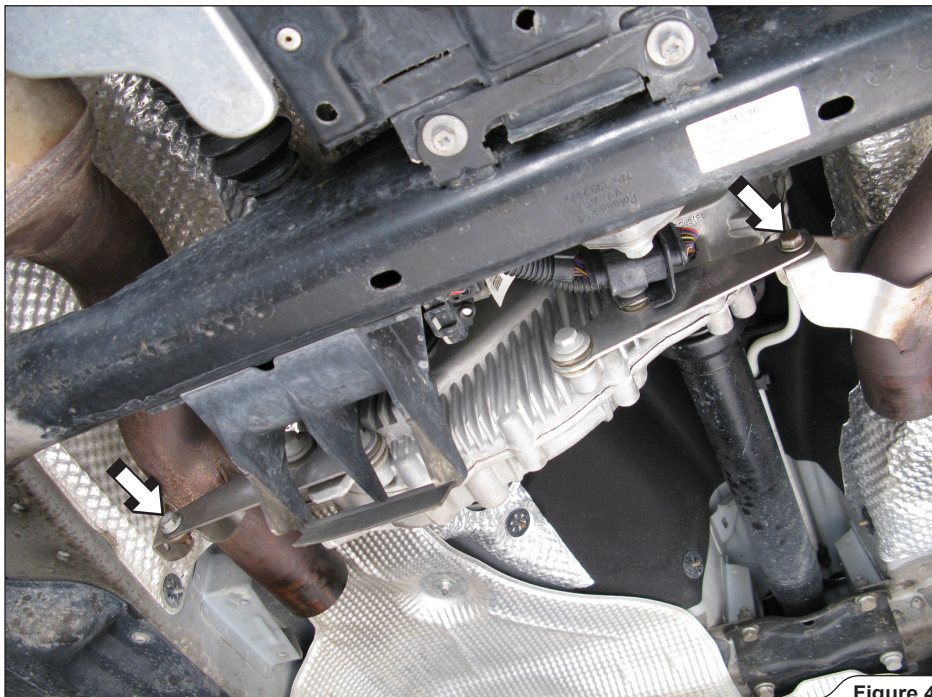

Figure 4

6. **For Optional Front Link Pipe Set only:** hand tighten the Akrapovič front link pipes onto the stock down pipes, using Akrapovič M8x25mm bolts, stock nuts and stock gaskets (**Figure 5, 6**).

- ! **CAUTION:** use new exhaust gaskets in Akrapovič link pipes - stock down pipes joints!
- ! **WARNING:** make sure not to injure yourself, or damage any part of the vehicle during this procedure!

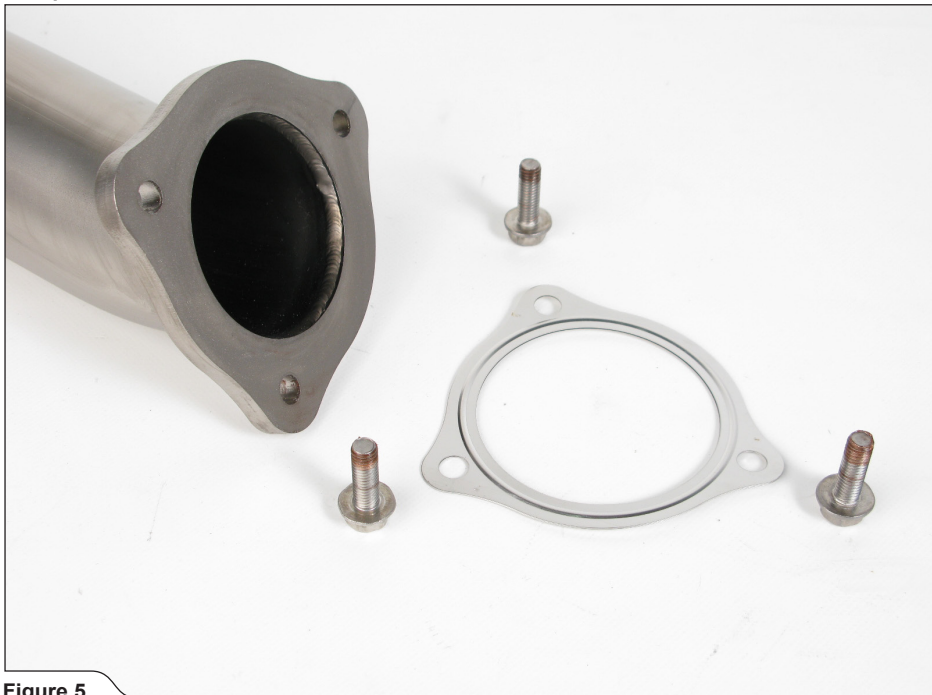

Figure 5

! WARNING: do not fully tighten the bolts and nuts yet (Figure 6)!

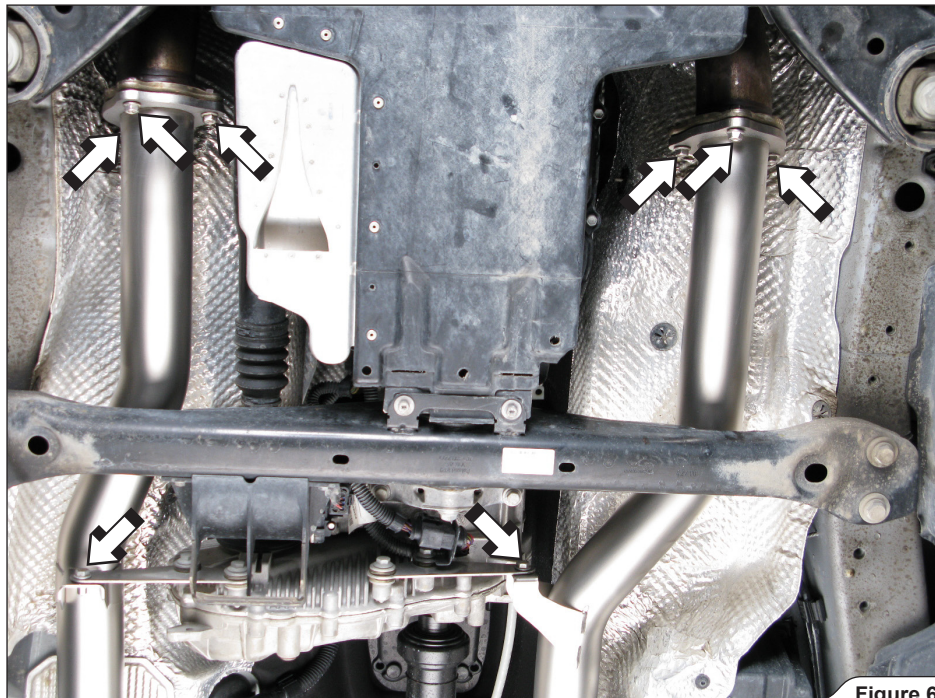

Figure 6

7. **For Optional Front Link Pipe Set only:** correctly assemble the clamps onto the Akrapovič middle pipes' inlets (**Figure 7**).

! **WARNING:** use anti-seize copper paste on clamps' bolt and nut threads!



Figure 7

8. **For Evolution system only:** correctly assemble the adapters and clamps onto the Akrapovič middle pipes' inlets (**Figure 8**).

! **WARNING:** only hand tighten all the clamps!

! **WARNING:** use anti-seize copper paste on clamps' bolt and nut threads!



Figure 8

9. For both systems: attach the stock rubber bracket onto the Akrapovič middle pipes (Figure 9).
-  **INSTALLATION TIP:** for easier mounting, lubricate the original rubber bracket (WD40).



Figure 9

10. **For Evolution system only:** slide the Akrapovič middle pipes with adapters all the way onto the stock pipes, adjust the all clamps and tighten them to the specified torque (**Figure 10**).

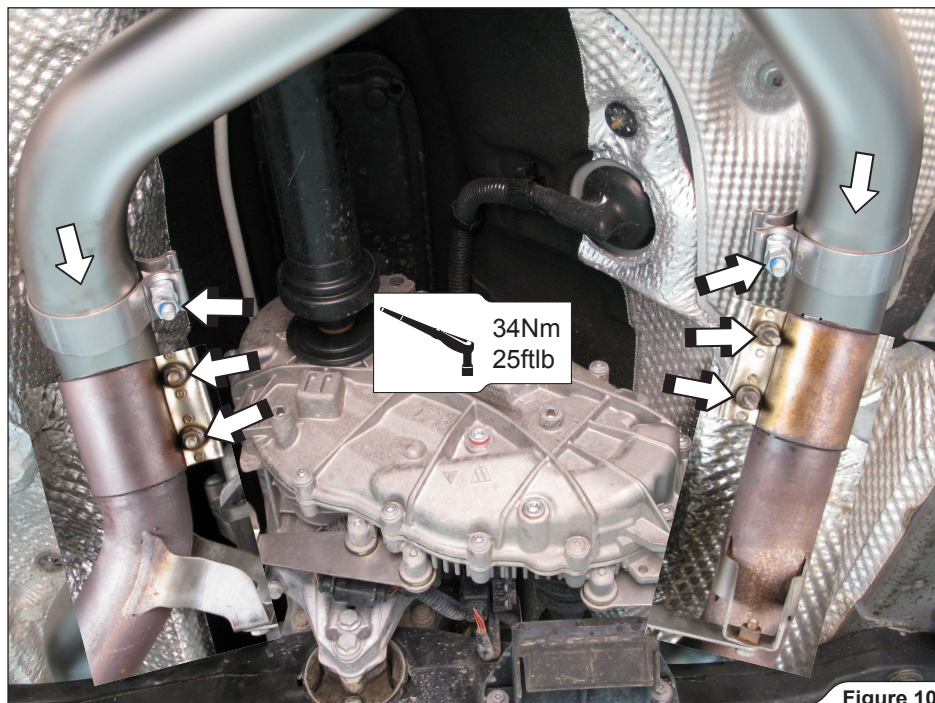

Figure 10

11. **For Optional Front Link Pipe Set only:** slide the Akrapovič middle pipes all the way onto the Akrapovič front link pipes, adjust the clamps and tighten them to the specified torque (Figure 11).

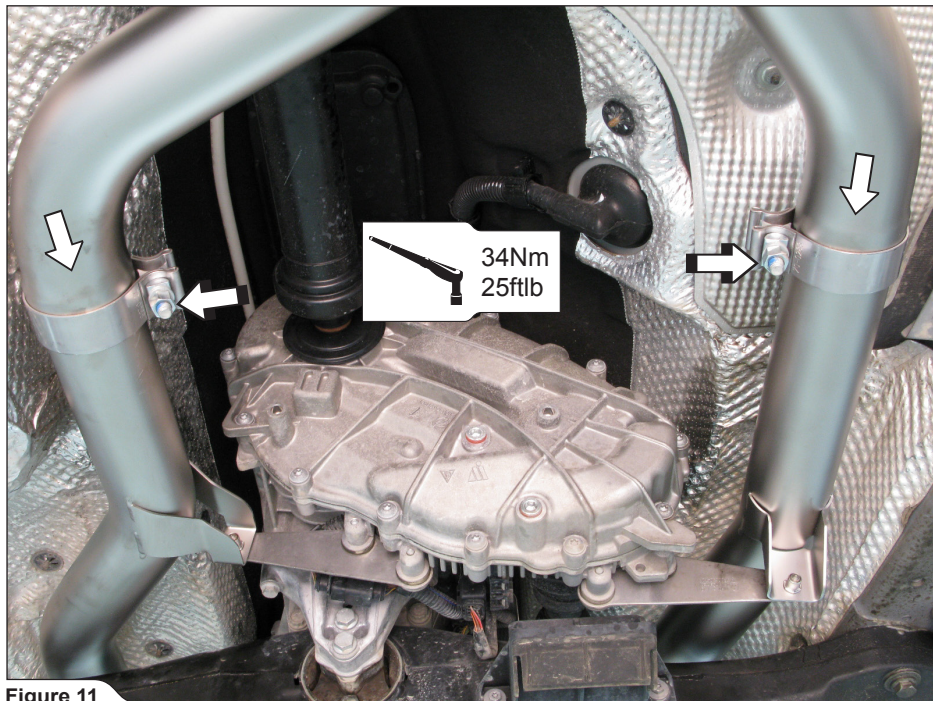

Figure 11

12. **For both systems:** tighten the rubber bracket onto the chassis, using stock bolt (**Figure 12**).

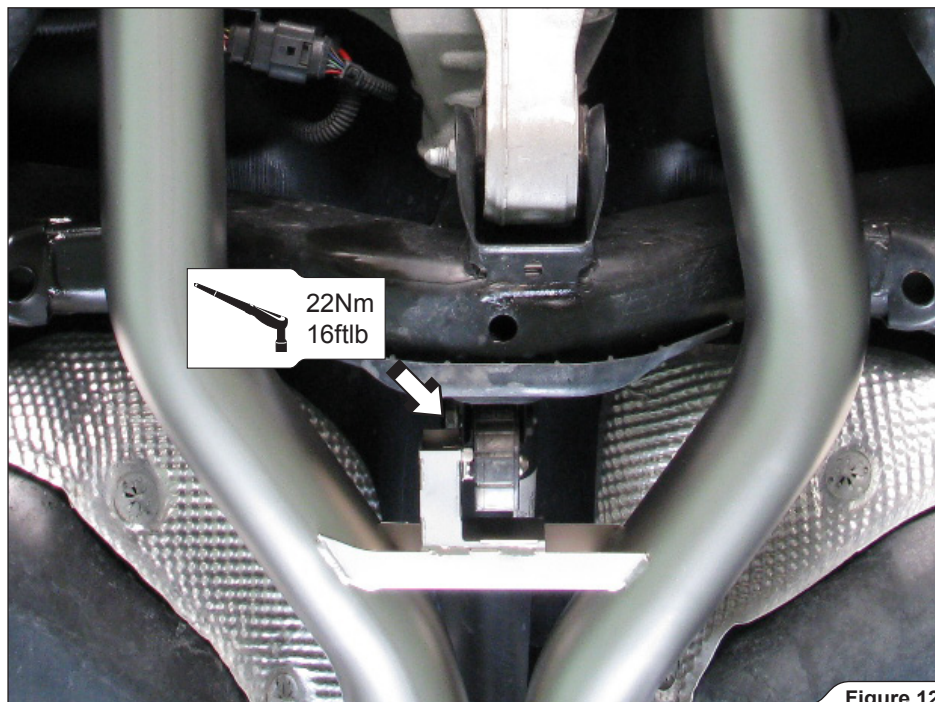

Figure 12

13. **For Optional Front Link Pipe Set only:** tighten the front link pipes' flanges and brackets to the specified torque (**Figure 13**).

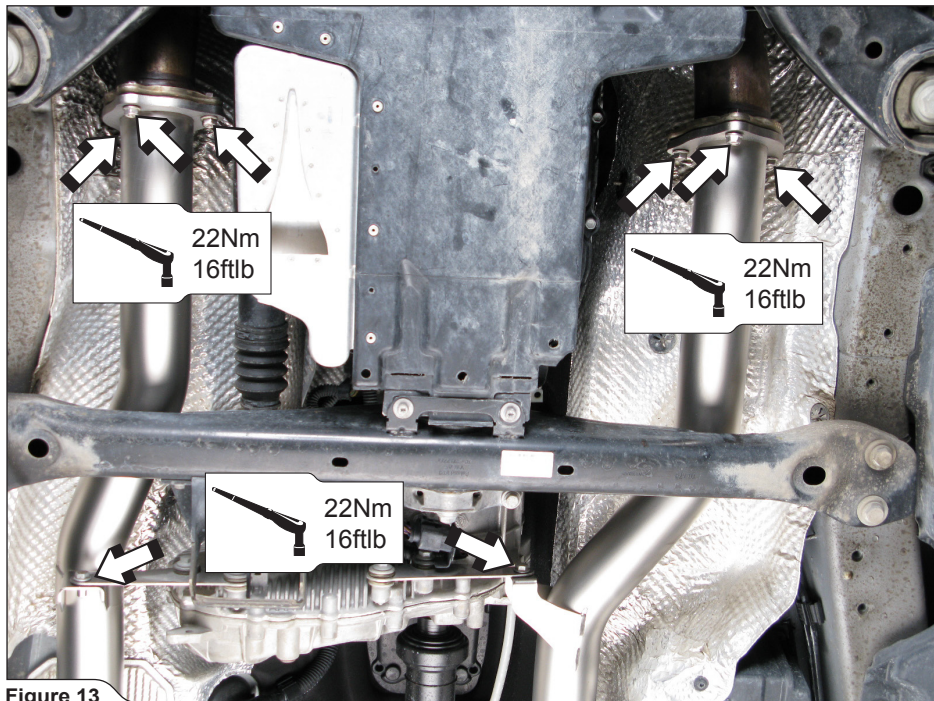

Figure 13

14. **For both systems:** correctly assemble the clamps onto the muffler link pipes (**Figure 14**).

! **WARNING: only hand tighten all the clamps!**

! **WARNING: use anti-seize copper paste on clamps' bolt and nut threads!**



Figure 14

15. **For both systems:** slide the muffler link pipes all the way onto the middle pipes, align the link pipes and hand tighten the clamps (**Figure 15**).

! **WARNING:** do not fully tighten the clamps yet!

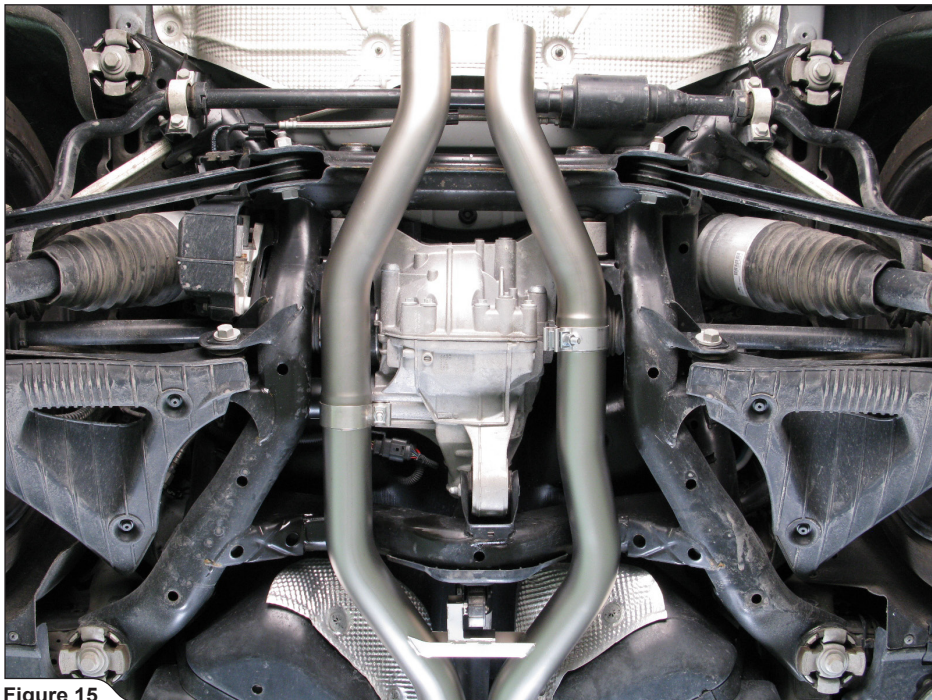



Figure 15

16. **For both systems:** install the Akrapovič muffler and tail pipes onto the vehicle.

 **INSTALLATION TIP:** check the Akrapovič Slip-On installation instructions for correct muffler installation procedure.

 **WARNING:** make sure, not to injure yourself or damage any part of the vehicle during this procedure!

Final installation:

- ! **WARNING: check vehicle manufacturer manual for tightening torques (for dismantled stock parts)!**
- ! **WARNING: make sure all the nuts and bolts are sufficiently tightened. In case the exhaust system touches the cowling or other parts, repeat the adjustment of the exhaust system or contact your authorized dealer.**

MAINTENANCE OF THE AKRAPOVIČ EXHAUST SYSTEM:

1. Clean the titanium exhaust components with a multi-purpose spray lubricant (WD-40 or equivalent), carbon fiber exhaust components with soft and dry cloth and stainless steel components with soft cloth sprayed with contact cleaner, then wipe with soft and dry cloth. A change in the color of the exhaust system is normal due to high temperatures.
2. Periodically make sure all the bolts and springs are sufficiently tight.

- ! **WARNING: clean all exhaust components before the first start of the engine or the stains will burn onto the surfaces!**

- ! **IT IS NORMAL FOR WHITE SMOKE TO COME OUT OF THE MUFFLER AT FIRST OPERATION.**
- ! **DO NOT STAND BEHIND THE MUFFLER AT FIRST OPERATION.**
- ! **DO NOT USE AUTOMOTIVE WHEEL CLEANERS OR ANY CLEANING PRODUCTS WHICH CONTAIN ACIDIC ADDITIVES TO CLEAN THE AKRAPOVIČ EXHAUST SYSTEMS.**

www.akrapovic.com

